

E-Box 150

Profibus® communication for SMART Digital S DDA (up to 30 l/h)

Installation and operating instructions



E-Box 150

English (GB)	
Installation and operating instructions	4
Čeština (CZ)	
Montážní a provozní návod	9
Deutsch (DE)	
Montage- und Betriebsanleitung	14
Dansk (DK)	
Monterings- og driftsinstruktion	19
Español (ES)	
Instrucciones de instalación y funcionamiento.	24
Suomi (FI)	
Asennus- ja käyttöohjeet	29
Français (FR)	
Notice d'installation et de fonctionnement.	34
Italiano (IT)	
Istruzioni di installazione e funzionamento	39
Polski (PL)	
Instrukcja montażu i eksploatacji.	44
Português (PT)	
Instruções de instalação e funcionamento	49
Română (RO)	
Instrucțiuni de instalare și utilizare	54
Русский (RU)	
Паспорт, Руководство по монтажу и эксплуатации.	59
中文 (CN)	
安装和使用说明书	64
日本語 (JP)	
取扱説明書	69
한국어 (KO)	
설치 및 작동 지침	74
Declaration of conformity	79
Declaration of conformity	81

English (GB) Installation and operating instructions

Original installation and operating instructions

Table of contents

1.	General information	4
2.	Symbols used in this document	4
3.	Product information	4
3.1	Applications	4
3.2	Product overview	4
3.3	Symbols on the product.	5
3.4	Nameplate.	5
4.	Installation	5
4.1	Installation kit	5
4.2	Electrical connection	5
4.3	Mechanical installation	6
5.	Technical data	7
5.1	Dimensions	8
6.	Cleaning	8
7.	Disposing of the product	8

1. General information



Read this document before you install the product. Installation and operation must comply with local regulations and accepted codes of good practice.

2. Symbols used in this document



WARNING

If these safety instructions are not observed, it may result in personal injury.

Caution

If these safety instructions are not observed, it may result in malfunction or damage to the equipment.

Note

Notes or instructions that make the job easier and ensure safe operation.

3. Product information



WARNING

- Prior to installation, read the installation and operating instructions of the relevant CIM module and of the DDA dosing pump.

3.1 Applications

The Grundfos E-Box 150 (E-Box = Extension Box) must only be used as a communication interface between a SMART digital DDA dosing pump and a Profibus® network.

The E-Box 150 contains a CIM 150 module (CIM = Communication Interface Module).

For internal communication between the E-Box and the dosing pump, GENibus is used.

3.2 Product overview

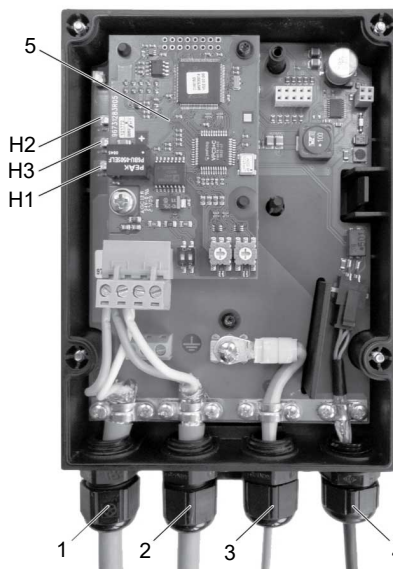

E-box overview



Pos.	Description
1	Profibus connection 1
2	Profibus connection 2
3	Optional functional earth connection *
4	Pre-assembled plug connection to dosing pump (contains power supply and GENibus connection)

TM079527

Pos.	Description
5	CIM 150 module
H1	LED: GENIbus Rx, yellow
H2	LED: Power, green
H3	LED: GENIbus Tx, red

* Depending on local network installation

3.3 Symbols on the product

Symbol	Description
	Indication of universally dangerous spot.
	Functional earth terminal.

3.4 Nameplate

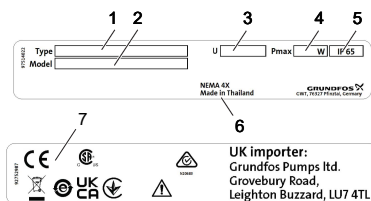

TM1040575

Pos.	Description
1	Type designation
2	Model
3	Voltage
4	Power consumption
5	Enclosure class
6	Country of origin
7	Marks of approval

4. Installation

4.1 Installation kit

The E-Box package contains these parts:

- E-Box equipped with CIM module
- Installation and operating instructions for the E-Box
- Installation and operating instructions for the CIM module

- CD-ROM (software, functional profiles, installation and operating instructions).

Note

Keep the CD-ROM and the installation and operating instructions so that they are easy to find when the E-Box with CIM module has to be integrated into the main communications network.

4.2 Electrical connection

The electrical connection must only be carried out by an authorised electrician in accordance with local regulations.

Warning



Before beginning the electrical connection, make sure that the power supply of the DDA dosing pump has been switched off, and that it cannot be accidentally switched on.

Warning



To ensure enclosure class IP65 / NEMA 4X, all unused connections have to be fitted with a blind plug!

Supply voltage of the E-Box: 30 VDC from DDA pump. See fig. E-box overview, pos. 4.

Caution

Connect E-box to power supply only via the DDA pump using the pre-assembled plug!

To ensure a stable and reliable communication, the cable screen for GENIbus connection must always be connected to the earth clamp. This is pre-assembled by Grundfos.

Caution

See fig. E-box overview, pos. 4. Do not make any changes!

Related information

[3.2 Product overview](#)

4.2.1 Connection of Profibus

Note

Depending on the local network installation, one or two cables can be connected to the Profibus connections (fig. [Cable connections](#), pos. 1 and 2).

1. Remove cover from E-Box.

2. Prepare Profibus cable(s) as shown in fig. [Preparation of Profibus cables](#).

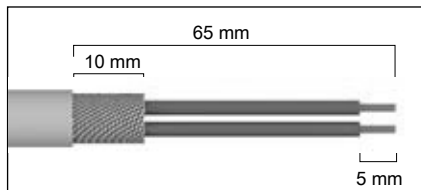

TM048440

Preparation of Profibus cables

See fig. [Cable connections](#).

3. Connect the red conductor(s) to terminal B (pos. 5).
4. Connect the green conductor(s) to terminal A (pos. 6).
5. Connect cable screens to earth via the earth clamps (pos. 7).
6. If necessary, connect earth conductor to functional earth terminal (pos. 8) at earth connection (pos. 3) and tighten clamp (pos. 9).
7. Fit housing cover and tighten screws.
 - Make sure that the gasket is positioned correctly.

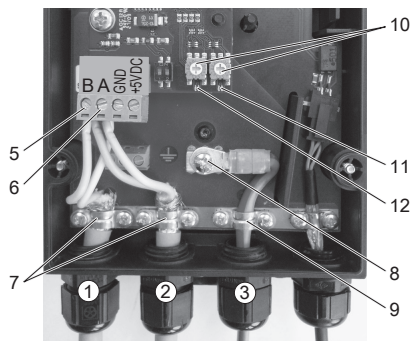

TM048441

Cable connections

The Profibus address is set via DDA pump menu. Therefore the rotary switches (fig. [Cable connections](#), pos. 10) have been deactivated from factory.

Note

The LED (fig. [Cable connections](#), pos. 11) indicates the status of GENIBus connection.

Note

The LED (fig. [Cable connections](#), pos. 12) indicates the status of Profibus connection.

For further information (e.g. setting of termination resistors) see installation and operating instructions of the CIM 150 module.

4.2.2 Connection of power supply and GENIBus

Prior to connection of power supply and GENIBus, execute the mechanical installation.

1. Switch off the power supply of the DDA dosing pump (pos. 1).
 - Wait for approx. 20 seconds before executing the next step.
2. Remove protective cap from BUS input of the pump.
3. Connect plug (pos. 4) thoroughly to BUS input of the pump.

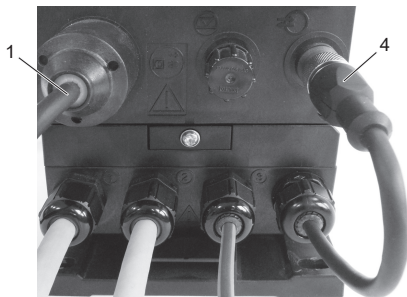

TM048442

Connecting E-Box to DDA

Start-up procedure and wiring diagram of plug, see installation and operating instructions of the DDA dosing pump.

Note

The functional profile can be found on the product CD delivered with the E-Box.

Related information

[4.3 Mechanical installation](#)

4.3 Mechanical installation

The E-box is always mounted below the pump regardless of the pump's mounting position (e.g. wall or tank mounted).

1. Place pump on E-Box.
 - Make sure that the clamps of the E-Box housing cover engage at pump housing (detail 1).
 - Insert locking device (pos. 5) at pump housing (detail 2).
2. Tighten screw (pos. 4) to lock connection (detail 3).

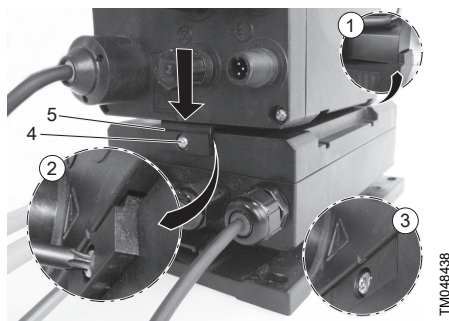

Mounting pump on E-Box

For horizontal installation, the E-Box can be mounted on the mounting plate of the DDA dosing pump.

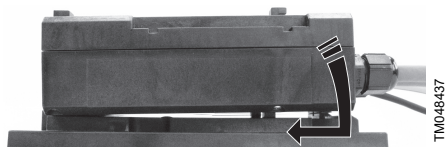

Mounting E-Box on mounting plate

TMO48438

TMO48437

5. Technical data

Electrical data	Supply voltage *	30 VDC, $\pm 10\%$
	Max. power consumption	5 W
	Cable size	IEC: $\geq 0.34\text{ mm}^2$ UL: $\geq 22\text{ AWG}$
	Recommended cable type	Profibus type A, shielded, twisted pair Max. cable length: 1200 m / 4000 ft
GENIbus connection	Transceiver	RS-485
	Protocol	GENIbus
	Transmission speed	9600 bits/s
Environmental conditions	Max. altitude above sea level	2000 m
	Max. relative humidity (non-condensing)	96 %
	Pollution degree	2
	Enclosure class	IP65 according to IEC 60529 NEMA 4X
	Electrical safety class	3
	Min./max. ambient temperature	0/45 °C
Approvals	CE, CB, CSA-US, RCM	
Weight	0.4 kg	

* Only from DDA dosing pump via pre-assembled plug connection

Caution The E-Box must not be exposed to direct sunlight.

5.1 Dimensions

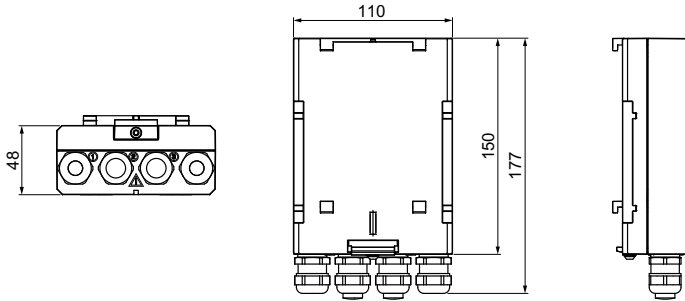

TM048453

6. Cleaning

The E-Box must only be cleaned with a dry and clean cloth.

7. Disposing of the product

This product or parts of it must be disposed of in an environmentally sound way:

1. Use the public or private waste collection service.
2. If this is not possible, contact the nearest Grundfos company or service workshop.

See also end-of-life information at www.grundfos.com/product-recycling.



The crossed-out wheellie bin symbol on a product means that it must be disposed of separately from household waste. When a product marked with this symbol reaches its end of life, take it to a collection point designated by the local waste disposal authorities.

The separate collection and recycling of such products will help protect the environment and human health.

Declaration of conformity

GB: EU declaration of conformity

We, Grundfos, declare under our sole responsibility that the product E-Box 150, to which the declaration below relates, is in conformity with the Council Directives listed below on the approximation of the laws of the EU member states.

DK: EU-overensstemmelseserklæring

Vi, Grundfos, erklærer under ansvar at produktet E-Box 150 som erklæringen nedenfor omhandler, er i overensstemmelse med Rådets direktiver der er nævnt nedenfor, om indbyrdes tilnærmelse til EU-medlemsstaternes lovgivning.

FI: EU-vaatimustenmukaisuusvakuutus

Grundfos vakuuttaa omalla vastuullaan, että tuote E-Box 150, jota tämä vakuutus koskee, on EU:n jäsenvaltioiden lainsäädännön lähentämiseen tähtäävien Euroopan neuvoston direktiivien vaatimusten mukainen seuraavasti.

IT: Dichiarazione di conformità UE

Grundfos dichiara sotto la sua esclusiva responsabilità che il prodotto E-Box 150, al quale si riferisce questa dichiarazione, è conforme alle seguenti direttive del Consiglio riguardanti il riavvicinamento delle legislazioni degli Stati membri UE.

PT: Declaração de conformidade UE

A Grundfos declara sob sua única responsabilidade que o produto E-Box 150, ao qual diz respeito a declaração abaixo, está em conformidade com as Directivas do Conselho sobre a aproximação das legislações dos Estados Membros da UE.

RU: Декларация о соответствии нормам ЕС

Мы, компания Grundfos, со всей ответственностью заявляем, что изделие E-Box 150, к которому относится нижеприведённая декларация, соответствует нижеприведённым Директивам Совета Евросоюза о тождественности законов стран-членов ЕС.

JP: EU 適合宣言

Grundfos は、その責任の下に、E-Box 150 製品が EU 加盟諸国の法規に関連する、以下の評議会指令に適合していることを宣言します。

DE: EU-Konformitätserklärung

Wir, Grundfos, erklären in alleiniger Verantwortung, dass das Produkt E-Box 150, auf das sich diese Erklärung bezieht, mit den folgenden Richtlinien des Rates zur Angleichung der Rechtsvorschriften der EU-Mitgliedsstaaten übereinstimmt.

ES: Declaración de conformidad de la UE

Grundfos declara, bajo su exclusiva responsabilidad, que el producto E-Box 150 al que hace referencia la siguiente declaración cumple lo establecido por las siguientes Directivas del Consejo sobre la aproximación de las legislaciones de los Estados miembros de la UE.

FR: Déclaration de conformité UE

Nous, Grundfos, déclarons sous notre seule responsabilité, que le produit E-Box 150, auquel se réfère cette déclaration, est conforme aux Directives du Conseil concernant le rapprochement des législations des États membres UE relatives aux normes énoncées ci-dessous.

PL: Deklaracja zgodności UE

My, Grundfos, oświadczamy z pełną odpowiedzialnością, że nasz produkt E-Box 150, którego deklaracja niniejsza dotyczy, jest zgodny z następującymi dyrektywami Rady w sprawie zbliżenia przepisów prawnych państw członkowskich.

RO: Declarația de conformitate UE

Noi Grundfos declarăm pe propria răspundere că produsul E-Box 150, la care se referă această declarație, este în conformitate cu Directivele de Consiliu specificate mai jos privind armonizarea legilor statelor membre UE.

CN: 欧盟符合性声明

我们，格兰富，在我们的全权责任下声明，产品 E-Box 150 系列，其制造和性能完全符合以下所列欧盟委员会指令。

KO: EU 적합성 선언

Grundfos는 아래의 선언과 관련된 E-Box 150 제품이 EU 회원국 법률에 기반하여 아래의 이사회 지침을 준수함을 단독 책임 하에 선언합니다.

- Low Voltage Directive (2014/35/EU).
Standard used:
EN 61010-1:2010.
- EMC Directive (2014/30/EU).
Standards used:
EN 61326-1:2013,
EN 61000-3-2:2019
EN 61000-3-3:2013 + A1:2019.
- RoHS Directives (2011/65/EU and 2015/863/EU).
Standard used:
EN IEC 63000:2018.

This EU declaration of conformity is only valid when published as part of the Grundfos installation and operating instructions (publication number 98103319).

Bjerringbro, 01.March 2022



Jimm Feldborg
Head of PD IND

Grundfos Holding A/S
Poul Due Jensens Vej 7
8850 Bjerringbro, Denmark

Person authorised to compile technical file and
empowered to sign the EU declaration of conformity.

Declaration of conformity

UK declaration of conformity

We, Grundfos, declare under our sole responsibility that the products to which the declaration below relates, are in conformity with UK regulations, standards and specifications to which conformity is declared, as listed below:

Valid for Grundfos products:

E-Box 150

- Electrical Equipment (Safety) Regulations 2016.
Standard used:
EN 61010-1:2010.
- Electromagnetic Compatibility Regulations 2016.
Standards used:
EN 61326-1:2013,
EN 61000-3-2:2019,
EN 61000-3-3:2013 + A1:2019.
- The Restriction of the Use of Certain Hazardous Substances in Electrical and Electronic Equipment Regulations 2019.
Standard used:
EN IEC 63000:2018.

This UK declaration of conformity is only valid when accompanying Grundfos instructions.

UK Importer: Grundfos Pumps Ltd. Grovebury Road,
Leighton Buzzard, LU7 4TL.

Bjerringbro, 01.March 2022



Jimm Feldborg
Head of PD IND

Grundfos Holding A/S
Poul Due Jensens Vej 7
8850 Bjerringbro, Denmark

Manufacturer and person empowered to sign the UK
declaration of conformity.

10000107479

DoC-Ukrainian-E-Box 150



GB: Ukrainian declaration of conformity

We, Grundfos, declare under our sole responsibility that the products to which the declaration below relates, are in conformity with Ukrainian resolutions, standards and specifications to which conformity is declared, as listed below:

Valid for Grundfos products:

E-Box 150

Resolution No. 1067, 2015 - Technical Regulation of Low Voltage Electrical Equipment

Standards used: ДСТУ EN 61010-1:2014

Resolution No. 1077, 2015 - Technical Regulations on Electromagnetic Compatibility

Standards used: : ДСТУ EN 61326-1:2016, ДСТУ EN 61000-3-2:2016, ДСТУ EN 61000-3-3:2017

Resolution No. 139, 2017 - Technical Regulations on Use of Certain Hazardous Substances in Electrical and Electronic Equipment

Standards used: ДСТУ EN IEC 63000:2020

Importer address:

LLC Grundfos Ukraine, Business Center Europe

103, Stolychne Shose, UA-03026 Kyiv, Ukraine

Phone: (+380) 44 237 0400

Email: ukraine@grundfos.com

This Ukrainian declaration of conformity is only valid when accompanying Grundfos instructions.



UA: Українська декларація відповідності

Ми, Grundfos, заявляємо про свою виключну відповідальність за те, що продукція, до якої відноситься ця декларація, відповідає вимогам українським постановам, стандартам та технічним умовам, щодо яких заявлена відповідність, як зазначено нижче:

Дійсно для продуктів Grundfos:

E-Box 150

Постанова № 1067 від 2015 р., Технічний регламент низьковольтного електричного обладнання

Застосовані стандарти: ДСТУ EN 61010-1:2014

Застосовані стандарти: ДСТУ EN 60335-1:2014, ДСТУ EN 60335-2-41:2015

Постанова № 1077 від 2015 р., Технічний регламент з електромагнітної сумісності обладнання

Застосовані стандарти: : ДСТУ EN 61326-1:2016, ДСТУ EN 61000-3-2:2016, ДСТУ EN 61000-3-3:2017

Постанова № 139 від 2017 р., Технічний регламент обмеження використання деяких небезпечних речовин в електричному та електронному обладнанні

Застосовані стандарти: ДСТУ EN IEC 63000:2020

Адреса імпортера:

ТОВ "Грундфос Україна", Бізнес Центр "Європа"

Столичне шосе, 103, м. Київ, 03026, Україна

Телефон: (+380) 44 237 0400

Ел. пошта: ukraine@grundfos.com

Ця українська декларація відповідності дійсна лише за наявності інструкцій Grundfos.

Bjerringbro, 04.03.2022

A handwritten signature in black ink that reads "Jimm Feldborg". The signature is written in a cursive, flowing style.

Jimm Feldborg
Head of PD IND
Grundfos Holding A/S
Poul Due Jensens Vej 7
8850 Bjerringbro, Denmark

GB: Manufacturer and person empowered to sign the Ukrainian declaration of conformity
UA: Виробник та особа, уповноважена підписати українську декларацію відповідності
[10000435788]

Argentina

Bombas GRUNDFOS de Argentina S.A.
Ruta Panamericana km. 37.500 Industrias
1610 - Garin Pcia. de B.A.
Tel.: +54-3327 414 444
Fax: +54-3327 45 3190

Australia

GRUNDFOS Pumps Pty. Ltd.
P.O. Box 2040
Regency Park
South Australia 5942
Tel.: +61-8-8461-4611
Fax: +61-8-8340-0155

Austria

GRUNDFOS Pumpen Vertrieb
Ges.m.b.H.
Grundfosstraße 2
A-5082 Grödig/Salzburg
Tel.: +43-6246-883-0
Fax: +43-6246-883-30

Belgium

N.V. GRUNDFOS Bellux S.A.
Boomssesteenweg 81-83
B-2630 Aartselaar
Tel.: +32-3-870 7300
Fax: +32-3-870 7301

Belarus

Представительство ГРУНДФОС в
Минске
220125, Минск
ул. Шафарнянская, 11, оф. 56, БЦ
«Порт»
Тел.: +375 17 397 397 3
+375 17 397 397 4
Факс: +375 17 397 397 1
E-mail: minsk@grundfos.com

Bosnia and Herzegovina

GRUNDFOS Sarajevo
Zmaja od Bosne 7-7A
BiH-71000 Sarajevo
Tel.: +387 33 592 480
Fax: +387 33 590 465
www.ba.grundfos.com
E-mail: grundfos@bih.net.ba

Brazil

BOMBAS GRUNDFOS DO BRASIL
Av. Humberto de Alencar Castelo
Branco, 630
CEP 09850 - 300
São Bernardo do Campo - SP
Tel.: +55-11 4393 5533
Fax: +55-11 4343 5015

Bulgaria

Grundfos Bulgaria EOOD
Slatina District
Iztocna Tangenta street no. 100
BG - 1592 Sofia
Tel.: +359 2 49 22 200
Fax: +359 2 49 22 201
E-mail: bulgaria@grundfos.bg

Canada

GRUNDFOS Canada inc.
2941 Brighton Road
Oakville, Ontario
L6H 6C9
Tel.: +1-905 829 9533
Fax: +1-905 829 9512

China

GRUNDFOS Pumps (Shanghai) Co. Ltd.
10F The Hub, No. 33 Suhong Road
Minhang District
Shanghai 201106 PRC
Tel.: +86 21 612 252 22
Fax: +86 21 612 253 33

Columbia

GRUNDFOS Colombia S.A.S.
Km 1.5 via Siberia-Cota Conj. Potrero
Chico,
Parque Empresarial Arcos de Cota Bod.
1A.
Cota, Cundinamarca
Tel.: +57(1)-2913444
Fax: +57(1)-8764586

Croatia

GRUNDFOS CROATIA d.o.o.
Buzinski prilaz 38, Buzin
HR-10010 Zagreb
Tel.: +385 1 6595 400
Fax: +385 1 6595 499
www.hr.grundfos.com

Czech Republic

GRUNDFOS Sales Czechia and Slovakia
s.r.o.
Čajkovského 21
779 00 Olomouc
Tel.: +420-585-716 111

Denmark

GRUNDFOS DK A/S
Martin Bachs Vej 3
DK-8850 Bjerringbro
Tel.: +45-87 50 50 50
Fax: +45-87 50 51 51
E-mail: info_GDK@grundfos.com
www.grundfos.com/DK

Estonia

GRUNDFOS Pumps Eesti OÜ
Peterburi tee 92G
11415 Tallinn
Tel.: + 372 606 1690
Fax: + 372 606 1691

Finland

OY GRUNDFOS Pumput AB
Trukkikuja 1
FI-01360 Vantaa
Tel.: +358-(0) 207 889 500

France

Pompes GRUNDFOS Distribution S.A.
Parc d'Activités de Chesnes
57, rue de Malacombe
F-38290 St. Quentin Fallavier (Lyon)
Tel.: +33-4 74 82 15 15
Fax: +33-4 74 94 10 51

Germany

GRUNDFOS GMBH
Schlüterstr. 33
40699 Erkrath
Tel.: +49-(0) 211 929 69-0
Fax: +49-(0) 211 929 69-3799
E-mail: infoservice@grundfos.de
Service in Deutschland:
kundendienst@grundfos.de

Greece

GRUNDFOS Hellas A.E.B.E.
20th km. Athinon-Markopoulou Av.
P.O. Box 71
GR-19002 Peania
Tel.: +0030-210-66 83 400
Fax: +0030-210-66 46 273

Hong Kong

GRUNDFOS Pumps (Hong Kong) Ltd.
Unit 1, Ground floor, Siu Wai industrial
Centre
29-33 Wing Hong Street & 68 King Lam
Street, Cheung Sha Wan
Kowloon
Tel.: +852-27861706 / 27861741
Fax: +852-27858664

Hungary

GRUNDFOS Hungária Kft.
Tópark u. 8
H-2045 Törökbalint
Tel.: +36-23 511 111
Fax: +36-23 511 111

India

GRUNDFOS Pumps india Private Limited
118 Old Mahabalipuram Road
Thoraiakkam
Chennai 600 097
Tel.: +91-44 2496 6800

Indonesia

PT GRUNDFOS Pompa
Graha intirub Lt. 2 & 3
Jln. Cililitan Besar No.454, Makasar,
Jakarta Timur
ID-Jakarta 13650
Tel.: +62 21-469-51900
Fax: +62 21-460 6910 / 460 6901

Ireland

GRUNDFOS (Ireland) Ltd.
Unit A, Merrywell Business Park
Ballymount Road Lower
Dublin 12
Tel.: +353-1-4089 800
Fax: +353-1-4089 830

Italy

GRUNDFOS Pompe Italia S.r.l.
Via Gran Sasso 4
I-20060 Truccazzano (Milano)
Tel.: +39-02-95838112
Fax: +39-02-95309290 / 95838461

Japan

GRUNDFOS Pumps K.K.
1-2-3, Shin-Miyakoda, Kita-ku
Hamamatsu
431-2103 Japan
Tel.: +81 53 428 4760
Fax: +81 53 428 5005

Korea

GRUNDFOS Pumps Korea Ltd.
6th Floor, Aju Building 679-5
Yeoksam-dong, Kangnam-ku, 135-916
Seoul, Korea
Tel.: +82-2-5317 600
Fax: +82-2-5633 725

Latvia

SIA GRUNDFOS Pumps Latvia
 Deglava biznesa centrs
 Augusta Deglava ielā 60
 LV-1035, Rīga,
 Tel.: + 371 714 9640, 7 149 641
 Fax: + 371 914 9646

Lithuania

GRUNDFOS Pumps UAB
 Smolensko g. 6
 LT-03201 Vilnius
 Tel.: + 370 52 395 430
 Fax: + 370 52 395 431

Malaysia

GRUNDFOS Pumps Sdn. Bhd.
 7 Jalan Peguam U1/25
 Glenmarie Industrial Park
 40150 Shah Alam, Selangor
 Tel.: +60-3-5569 2922
 Fax: +60-3-5569 2866

Mexico

Bombas GRUNDFOS de México
 S.A. de C.V.
 Boulevard TLC No. 15
 Parque industrial Stiva Aeropuerto
 Apodaca, N.L. 66600
 Tel.: +52-81-8144 4000
 Fax: +52-81-8144 4010

Netherlands

GRUNDFOS Netherlands
 Veluwezoom 35
 1326 AE Almere
 Postbus 22015
 1302 CA ALMERE
 Tel.: +31-88-478 6336
 Fax: +31-88-478 6332
 E-mail: info_gnl@grundfos.com

New Zealand

GRUNDFOS Pumps NZ Ltd.
 17 Beatrice Tinsley Crescent
 North Harbour Industrial Estate
 Albany, Auckland
 Tel.: +64-9-415 3240
 Fax: +64-9-415 3250

Norway

GRUNDFOS Pumper A/S
 Strømsveien 344
 Postboks 235, Leirdal
 N-1011 Oslo
 Tel.: +47-22 90 47 00
 Fax: +47-22 32 21 50

Poland

GRUNDFOS Pompy Sp. z o.o.
 ul. Klonowa 23
 Baranowo k. Poznania
 PL-62-081 Przemierowo
 Tel.: (+48-61) 650 13 00
 Fax: (+48-61) 650 13 50

Portugal

Bombas GRUNDFOS Portugal, S.A.
 Rua Calvet de Magalhães, 241
 Apartado 1079
 P-2770-153 Paço de Arcos
 Tel.: +351-21-440 76 00
 Fax: +351-21-440 76 90

Romania

GRUNDFOS Pompe România SRL
 S-PARK BUSINESS CENTER, Clădirea
 A2, etaj 2
 Str. Tipografilor, Nr. 11-15, Sector 1, Cod
 013714
 Bucuresti, Romania
 Tel.: 004 021 2004 100
 E-mail: romania@grundfos.ro

Russia

ООО Грундфос Россия
 ул. Школьная, 39-41
 Москва, RU-109544, Russia
 Тел. (+7) 495 564-88-00 (495) 737-30-00
 Факс (+7) 495 564 8811
 E-mail grundfos.moscow@grundfos.com

Serbia

Grundfos Srbija d.o.o.
 Omladinskih brigada 90b
 11070 Novi Beograd
 Tel.: +381 11 2258 740
 Fax: +381 11 2281 769
 www.rs.grundfos.com

Singapore

GRUNDFOS (Singapore) Pte. Ltd.
 25 Jalan Tukang
 Singapore 619264
 Tel.: +65-6681 9688
 Fax: +65-6681 9689

Slovakia

GRUNDFOS s.r.o.
 Prievozská 4D 821 09 BRATISLAVA
 Tel.: +421 2 5020 1426
 sk.grundfos.com

Slovenia

GRUNDFOS LJUBLJANA, d.o.o.
 Leskoškova 9e, 1122 Ljubljana
 Tel.: +386 (0) 1 568 06 10
 Fax: +386 (0)1 568 06 19
 E-mail: tehnika-si@grundfos.com

South Africa

GRUNDFOS (PTY) LTD
 16 Lascelles Drive, Meadowbrook Estate
 1609 Germiston, Johannesburg
 Tel.: (+27) 10 248 6000
 Fax: (+27) 10 248 6002
 E-mail: lgradidge@grundfos.com

Spain

Bombas GRUNDFOS España S.A.
 Camino de la Fuentesilla, s/n
 E-28110 Algete (Madrid)
 Tel.: +34-91-848 8800
 Fax: +34-91-628 0465

Sweden

GRUNDFOS AB
 Box 333 (Lunnagårdsgatan 6)
 431 24 Mölndal
 Tel.: +46 31 332 23 000
 Fax: +46 31 331 94 60

Switzerland

GRUNDFOS Pumpen AG
 Bruggacherstrasse 10
 CH-8117 Fällanden/ZH
 Tel.: +41-44-806 8111
 Fax: +41-44-806 8115

Taiwan

GRUNDFOS Pumps (Taiwan) Ltd.
 7 Floor, 219 Min-Chuan Road
 Taichung, Taiwan, R.O.C.
 Tel.: +886-4-2305 0868
 Fax: +886-4-2305 0878

Thailand

GRUNDFOS (Thailand) Ltd.
 92 Chalome Phrakiat Rama 9 Road
 Dokmai, Pravej, Bangkok 10250
 Tel.: +66-2-725 8999
 Fax: +66-2-725 8998

Turkey

GRUNDFOS POMPA San. ve Tic. Ltd.
 Sti.
 Gebze Organize Sanayi Bölgesi
 Ihsan dede Caddesi
 2. yol 200. Sokak No, 204
 41490 Gebze/ Kocaeli
 Tel.: +90 - 262-679 7979
 Fax: +90 - 262-679 7905
 E-mail: satis@grundfos.com

Ukraine

ТОВ "ГРУНДФОС УКРАЇНА"
 Бізнес Центр Європа
 Столицне шосе, 103
 м. Київ, 03131, Україна
 Tel.: (+38 044) 237 04 00
 Fax: (+38 044) 237 04 01
 E-mail: ukraine@grundfos.com

United Arab Emirates

GRUNDFOS Gulf Distribution
 P.O. Box 16768
 Jebel Ali Free Zone, Dubai
 Tel.: +971 4 8815 166
 Fax: +971 4 8815 136

United Kingdom

GRUNDFOS Pumps Ltd.
 Grovebury Road
 Leighton Buzzard/Beds. LU7 4TL
 Tel.: +44-1525-850000
 Fax: +44-1525-850011

U.S.A.

Global Headquarters for WU
 856 Koomey Road
 Brookshire, Texas 77423 USA
 Phone: +1-630-236-5500

Uzbekistan

Grundfos Tashkent, Uzbekistan
 The Representative Office of Grundfos
 Kazakhstan in Uzbekistan
 38a, Oybek street, Tashkent
 Tel.: (+998) 71 150 3290 / 71 150 3291
 Fax: (+998) 71 150 3292

98103319 04.2022

ECM: 1337196

www.grundfos.com

GRUNDFOS 