

# E-Box 200

Modbus communication for SMART Digital S DDA (up to 30 l/h)

Installation and operating instructions





## E-Box 200

---

<b>English (GB)</b>	
Installation and operating instructions . . . . .	4
<b>Čeština (CZ)</b>	
Montážní a provozní návod . . . . .	9
<b>Deutsch (DE)</b>	
Montage- und Betriebsanleitung . . . . .	14
<b>Dansk (DK)</b>	
Monterings- og driftsinstruktion . . . . .	19
<b>Español (ES)</b>	
Instrucciones de instalación y funcionamiento. . . . .	24
<b>Français (FR)</b>	
Notice d'installation et de fonctionnement. . . . .	29
<b>Italiano (IT)</b>	
Istruzioni di installazione e funzionamento . . . . .	34
<b>Polski (PL)</b>	
Instrukcja montażu i eksploatacji. . . . .	39
<b>Português (PT)</b>	
Instruções de instalação e funcionamento . . . . .	44
<b>Русский (RU)</b>	
Паспорт, Руководство по монтажу и эксплуатации. . . . .	49
<b>Svenska (SE)</b>	
Monterings- och driftsinstruktion . . . . .	54
<b>中文 (CN)</b>	
安装和使用说明书 . . . . .	59
<b>日本語 (JP)</b>	
取扱説明書. . . . .	64
<b>한국어 (KO)</b>	
설치 및 작동 지침 . . . . .	69
<b>Declaration of conformity . . . . .</b>	<b>74</b>
<b>Declaration of conformity . . . . .</b>	<b>76</b>
<b>Declaration of conformity . . . . .</b>	<b>77</b>

# English (GB) Installation and operating instructions

## Original installation and operating instructions

### Table of contents

- 1. **General information** . . . . . 4
- 2. **Symbols used in this document** . . . . . 4
- 3. **Product information** . . . . . 4
  - 3.1 Applications . . . . . 4
  - 3.2 Product overview . . . . . 4
  - 3.3 Symbols on the product. . . . . 5
  - 3.4 Nameplate. . . . . 5
- 4. **Installation** . . . . . 5
  - 4.1 Installation kit . . . . . 5
  - 4.2 Electrical connection . . . . . 5
  - 4.3 Mechanical installation . . . . . 6
- 5. **Technical data** . . . . . 7
  - 5.1 Dimensions . . . . . 8
- 6. **Cleaning** . . . . . 8
- 7. **Disposing of the product** . . . . . 8

## 1. General information



Read this document before you install the product. Installation and operation must comply with local regulations and accepted codes of good practice.

## 2. Symbols used in this document



**WARNING**  
If these safety instructions are not observed, it may result in personal injury.

Caution

If these safety instructions are not observed, it may result in malfunction or damage to the equipment.

Note

Notes or instructions that make the job easier and ensure safe operation.

## 3. Product information



**WARNING**  
- Prior to installation, read the installation and operating instructions of the relevant CIM module and of the DDA dosing pump.

## 3.1 Applications

The Grundfos E-Box 200 (E-Box = Extension Box) must only be used as a communication interface between a SMART digital DDA dosing pump and a Modbus network.

The E-Box 200 contains a CIM 200 module (CIM = Communication Interface Module).

For internal communication between the E-Box and the dosing pump, GENIBus is used.

## 3.2 Product overview

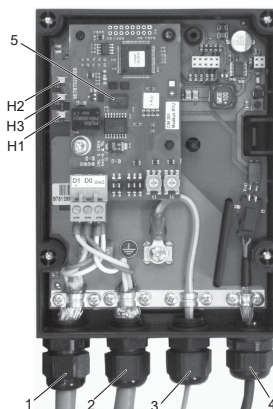



E-box overview

Pos.	Description
1	Modbus connection 1
2	Modbus connection 2
3	Optional functional earth connection*
4	Pre-assembled plug connection to dosing pump (contains power supply and GENIBus connection)
5	CIM 200 module
H1	LED: GENIBus Rx, yellow
H2	LED: Power, green
H3	LED: GENIBus Tx, red

\*Depending on local network installation.

TMD46897

### 3.3 Symbols on the product

Symbol	Description
	Indication of universally dangerous spot.
	Functional earth terminal.

### 3.4 Nameplate

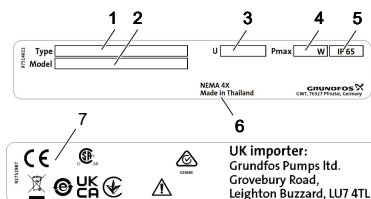

TM1040575

Pos.	Description
1	Type designation
2	Model
3	Voltage
4	Power consumption
5	Enclosure class
6	Country of origin
7	Marks of approval

## 4. Installation

### 4.1 Installation kit

The E-Box package contains these parts:

- E-Box equipped with CIM module
- Installation and operating instructions for the E-Box
- Installation and operating instructions for the CIM module
- CD-ROM (software, functional profiles, installation and operating instructions).

Keep the CD-ROM and the installation and operating instructions so that they are easy to find when the E-Box with CIM module has to be integrated into the main communications network.

Note

### 4.2 Electrical connection

The electrical connection must only be carried out by an authorised electrician in accordance with local regulations.

Warning



Before beginning the electrical connection, make sure that the power supply of the DDA dosing pump has been switched off, and that it cannot be accidentally switched on.

Warning



To ensure enclosure class IP65 / NEMA 4X, all unused connections have to be fitted with a blind plug!

Supply voltage of the E-Box: 30 VDC from DDA pump. See fig. E-box overview, pos. 4.

Caution

Connect E-box to power supply only via the DDA pump using the pre-assembled plug!

To ensure a stable and reliable communication, the cable screen for GENIBus connection must always be connected to the earth clamp. This is pre-assembled by Grundfos.

Caution

See fig. E-box overview, pos. 4. Do not make any changes!

### Related information

[3.2 Product overview](#)

### 4.2.1 Connection of Modbus

Depending on the local network installation, one or two cables can be connected to the Modbus connections (fig. Cable connections, pos. 1 and 2).

Note

1. Remove cover from E-Box.
2. Prepare Modbus cable(s) as shown.

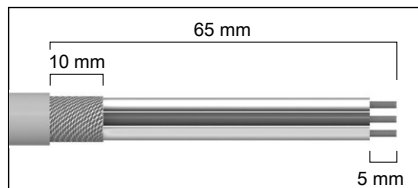

TM046998

#### Preparation of Modbus cables

3. Connect the yellow conductor(s) to terminal D1 (pos. 4).
4. Connect the brown conductor(s) to terminal D0 (pos. 5).

5. Connect the grey conductor(s) to terminal GND (pos. 6).
6. Connect cable screens to earth via the earth clamps (pos. 7).
7. If necessary, connect earth conductor to functional earth terminal (pos. 8) at earth connection (pos. 3) and tighten clamp (pos. 9).
8. Fit housing cover and tighten screws.
  - Make sure that the gasket is positioned correctly.

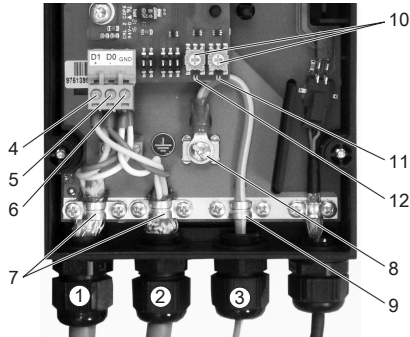

Cable connections

**Note** The Modbus address is set via DDA pump menu. Therefore the rotary switches (pos. 10) have been deactivated from factory.

The LED (pos. 11) indicates the status of GENibus connection.

**Note** The LED (pos. 12) indicates the status of Modbus connection.

For further information (e.g. setting of termination resistors) see installation and operating instructions of the CIM 200 module.

#### 4.2.2 Connection of power supply and GENibus

Prior to connection of power supply and GENibus, execute the mechanical installation.

1. Switch off the power supply of the DDA dosing pump (pos. 1).
  - Wait for approx. 20 seconds before executing the next step.
2. Remove protective cap from BUS input of the pump.
3. Connect plug (pos. 4) thoroughly to BUS input of the pump.

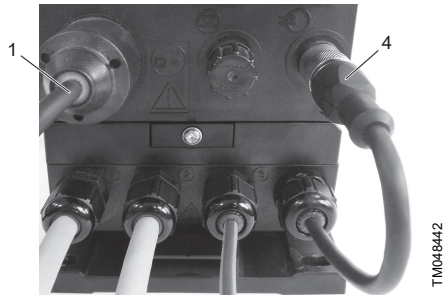

Connecting E-Box to DDA

Start-up procedure and wiring diagram of plug, see installation and operating instructions of the DDA dosing pump.

The functional profile can be found on the product CD delivered with the E-Box.

#### Related information

##### 4.3 Mechanical installation

#### 4.3 Mechanical installation

The E-box is always mounted below the pump regardless of the pump's mounting position (e.g. wall or tank mounted).

1. Place pump on E-Box.
  - Make sure that the clamps of the E-Box housing cover engage at pump housing (detail 1).
  - Insert locking device (pos. 5) at pump housing (detail 2).
2. Tighten screw (pos. 4) to lock connection (detail 3).

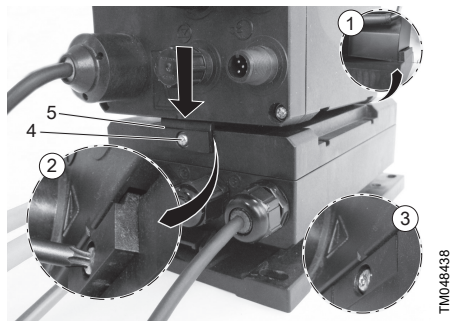

Mounting pump on E-Box

For horizontal installation, the E-Box can be mounted on the mounting plate of the DDA dosing pump.

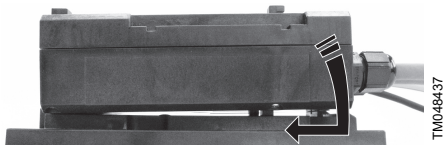

Mounting E-Box on mounting plate

## 5. Technical data

<b>Electrical data</b>	Supply voltage*	30 VDC, $\pm 10\%$
	Max. power consumption	5 W
	Cable	Screened, twisted-pair
		Min. 0.25 mm <sup>2</sup> Min. 23 AWG
	Max. cable length	1200 m 4000 ft
<b>GENIBus connection</b>	Transceiver	RS-485
	Protocol	GENIBus
	Transmission speed	9600 bits/s
<b>Environmental conditions</b>	Max. altitude above sea level	2000 m
	Max. relative humidity (non-condensing)	96 %
	Pollution degree	2
	Enclosure class	IP65 according to IEC 60529 NEMA 4X
	Electrical safety class	3
	Min./max. ambient temperature	0/45 °C
<b>Approvals</b>	CE, CB, CSA-US, RCM	
<b>Weight</b>	0.4 kg	

\* Only from DDA dosing pump via pre-assembled plug connection

**Caution** The E-Box must not be exposed to direct sunlight.

## 5.1 Dimensions

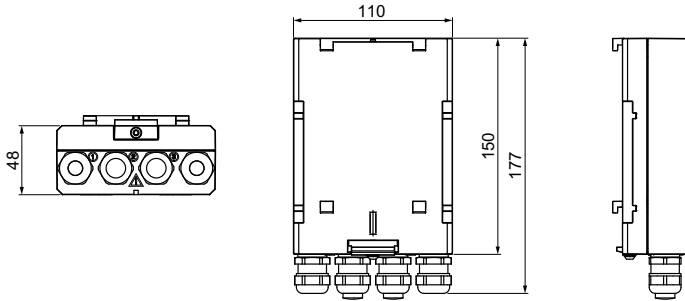

TM048453

## 6. Cleaning

The E-Box must only be cleaned with a dry and clean cloth.

## 7. Disposing of the product

This product or parts of it must be disposed of in an environmentally sound way:

1. Use the public or private waste collection service.
2. If this is not possible, contact the nearest Grundfos company or service workshop.

See also end-of-life information at [www.grundfos.com/product-recycling](http://www.grundfos.com/product-recycling).



The crossed-out wheeled bin symbol on a product means that it must be disposed of separately from household waste. When a product marked with this symbol reaches its end of life, take it to a collection point designated by the local waste disposal authorities.

The separate collection and recycling of such products will help protect the environment and human health.



## Declaration of conformity

### GB: EU declaration of conformity

We, Grundfos, declare under our sole responsibility that the product E-Box 200, to which the declaration below relates, is in conformity with the Council Directives listed below on the approximation of the laws of the EU member states.

### DE: EU-Konformitätserklärung

Wir, Grundfos, erklären in alleiniger Verantwortung, dass das Produkt E-Box 200, auf das sich diese Erklärung bezieht, mit den folgenden Richtlinien des Rates zur Angleichung der Rechtsvorschriften der EU-Mitgliedsstaaten übereinstimmt.

### ES: Declaración de conformidad de la UE

Grundfos declara, bajo su exclusiva responsabilidad, que el producto E-Box 200 al que hace referencia la siguiente declaración cumple lo establecido por las siguientes Directivas del Consejo sobre la aproximación de las legislaciones de los Estados miembros de la UE.

### IT: Dichiarazione di conformità UE

Grundfos dichiara sotto la sua esclusiva responsabilità che il prodotto E-Box 200, al quale si riferisce questa dichiarazione, è conforme alle seguenti direttive del Consiglio riguardanti il riavvicinamento delle legislazioni degli Stati membri UE.

### PT: Declaração de conformidade UE

A Grundfos declara sob sua única responsabilidade que o produto E-Box 200, ao qual diz respeito a declaração abaixo, está em conformidade com as Directivas do Conselho sobre a aproximação das legislações dos Estados Membros da UE.

### SE: EU-försäkran om överensstämmelse

Vi, Grundfos, försäkrar under ansvar att produkten E-Box 200, som omfattas av nedanstående försäkran, är i överensstämmelse med de rådsdirektiv om inbördes närmande till EU-medlemsstaternas lagstiftning som listas nedan.

### JP: EU 適合宣言

Grundfos は、その責任の下に、E-Box 200 製品が EU 加盟諸国の法規に関連する、以下の評議会指令に適合していることを宣言します。

### CZ: Prohlášení o shodě EU

My firma Grundfos prohlašujeme na svou plnou odpovědnost, že výrobek E-Box 200, na který se toto prohlášení vztahuje, je v souladu s níže uvedenými ustanoveními směrnice Rady pro sblížení právních předpisů členských států Evropského společenství.

### DK: EU-overensstemmelseserklæring

Vi, Grundfos, erklærer under ansvar at produktet E-Box 200 som erklæringen nedenfor omhandler, er i overensstemmelse med Rådets direktiver der er nævnt nedenfor, om indbyrdes tilnærmelse til EU-medlemsstaternes lovgivning.

### FR: Déclaration de conformité UE

Nous, Grundfos, déclarons sous notre seule responsabilité, que le produit E-Box 200, auquel se réfère cette déclaration, est conforme aux Directives du Conseil concernant le rapprochement des législations des États membres UE relatives aux normes énoncées ci-dessous.

### PL: Deklaracja zgodności UE

My, Grundfos, oświadczamy z pełną odpowiedzialnością, że nasz produkt E-Box 200, którego deklaracja niniejsza dotyczy, jest zgodny z następującymi dyrektywami Rady w sprawie zbliżenia przepisów prawnych państw członkowskich.

### RU: Декларация о соответствии нормам ЕС

Мы, компания Grundfos, со всей ответственностью заявляем, что изделие E-Box 200, к которому относится нижеприведённая декларация, соответствует нижеприведённым Директивам Совета Евросоюза о тождественности законов стран-членов ЕС.

### CN: 欧盟符合性声明

我们，格兰富，在我们的全权责任下声明，产品 E-Box 200 系列，其制造和性能完全符合以下所列欧盟委员会指令。

### KO: EU 적합성 선언

Grundfos는 아래의 선언과 관련된 E-Box 200 제품이 EU 회원국 법률에 기반하여 아래의 이사회 지침을 준수함을 단독 책임 하에 선언합니다.

- Low Voltage Directive (2014/35/EU).  
Standard used:  
EN 61010-1:2010.
- EMC Directive (2014/30/EU).  
Standards used:  
EN 61326-1:2013,  
EN 61000-3-2:2019,  
EN 61000-3-3:2013 + A1:2019.
- RoHS Directives (2011/65/EU and 2015/863/EU).  
Standard used:  
EN IEC 63000:2018.

This EU declaration of conformity is only valid when published as part of the Grundfos installation and operating instructions (publication number 98552055)..

Bjerringbro, 01.March 2022



Jimm Feldborg  
Head of PD IND  
Grundfos Holding A/S  
Poul Due Jensens Vej 7  
8850 Bjerringbro, Denmark

Person authorised to compile technical file and empowered to sign the EU declaration of conformity.

## Declaration of conformity

---

### UK declaration of conformity

We, Grundfos, declare under our sole responsibility that the products to which the declaration below relates, are in conformity with UK regulations, standards and specifications to which conformity is declared, as listed below:

Valid for Grundfos products:

E-Box 200

---

- Electrical Equipment (Safety) Regulations 2016  
Standard used:  
EN 61010-1:2010.
- Electromagnetic Compatibility Regulations 2016  
Standards used:  
EN 61326-1:2013,  
EN 61000-3-2:2019,  
EN 61000-3-3:2013 + A1:2019.
- The Restriction of the Use of Certain Hazardous Substances in Electrical and Electronic Equipment Regulations 2019.  
Standard used:  
EN IEC 63000:2018.

This UK declaration of conformity is only valid when accompanying Grundfos instructions.

UK Importer: Grundfos Pumps Ltd. Grovebury Road,  
Leighton Buzzard, LU7 4TL.

Bjerringbro, 01.March 2022



Jimm Feldborg  
Head of PD IND

Grundfos Holding A/S  
Poul Due Jensens Vej 7  
8850 Bjerringbro, Denmark

Manufacturer and person empowered to sign the UK  
declaration of conformity.

10000107487

## Declaration of conformity

---



GB: Ukrainian declaration of conformity

We, Grundfos, declare under our sole responsibility that the products to which the declaration below relates, are in conformity with Ukrainian resolutions, standards and specifications to which conformity is declared, as listed below:

Valid for Grundfos products:

E-Box 200

**Resolution No. 1067, 2015 - Technical Regulation of Low Voltage Electrical Equipment**

Standards used: ДСТУ EN 61010-1:2014

**Resolution No. 1077, 2015 - Technical Regulations on Electromagnetic Compatibility**

Standards used: : ДСТУ EN 61326-1:2016, ДСТУ EN 61000-3-2:2016, ДСТУ EN 61000-3-3:2017

**Resolution No. 139, 2017 - Technical Regulations on Use of Certain Hazardous Substances in Electrical and Electronic Equipment**

Standards used: ДСТУ EN IEC 63000:2020

Importer address:

LLC Grundfos Ukraine, Business Center Europe

103, Stolychne Shose, UA-03026 Kyiv, Ukraine

Phone: (+380) 44 237 0400

Email: ukraine@grundfos.com

This Ukrainian declaration of conformity is only valid when accompanying Grundfos instructions.

---



UA: Українська декларація відповідності

Ми, Grundfos, заявляємо про свою виключну відповідальність за те, що продукція, до якої відноситься ця декларація, відповідає вимогам українським постановам, стандартам та технічним умовам, щодо яких заявлена відповідність, як зазначено нижче:

Дійсно для продуктів Grundfos:

E-Box 200

**Постанова № 1067 від 2015 р., Технічний регламент низьковольтного електричного обладнання**

Застосовані стандарти: ДСТУ EN 61010-1:2014

Застосовані стандарти: ДСТУ EN 60335-1:2014, ДСТУ EN 60335-2-41:2015

**Постанова № 1077 від 2015 р., Технічний регламент з електромагнітної сумісності обладнання**

Застосовані стандарти: : ДСТУ EN 61326-1:2016, ДСТУ EN 61000-3-2:2016, ДСТУ EN 61000-3-3:2017

**Постанова № 139 від 2017 р., Технічний регламент обмеження використання деяких небезпечних речовин в електричному та електронному обладнанні**

Застосовані стандарти: ДСТУ EN IEC 63000:2020

Адреса імпортера:

ТОВ "Грундфос Україна", Бізнес Центр "Європа"

Столичне шосе, 103, м. Київ, 03026, Україна

Телефон: (+380) 44 237 0400

Ел. пошта: ukraine@grundfos.com

Ця українська декларація відповідності дійсна лише за наявності інструкцій Grundfos.

---

**Argentina**

Bombas GRUNDFOS de Argentina S.A.  
Ruta Panamericana km. 37.500 Industrias  
1610 - Garin Pcia. de B.A.  
Tel.: +54-3327 414 444  
Fax: +54-3327 45 3190

**Australia**

GRUNDFOS Pumps Pty. Ltd.  
P.O. Box 2040  
Regency Park  
South Australia 5942  
Tel.: +61-8-8461-4611  
Fax: +61-8-8340-0155

**Austria**

GRUNDFOS Pumpen Vertrieb  
Ges.m.b.H.  
Grundfosstraße 2  
A-5082 Grödig/Salzburg  
Tel.: +43-6246-883-0  
Fax: +43-6246-883-30

**Belgium**

N.V. GRUNDFOS Bellux S.A.  
Boomssesteenweg 81-83  
B-2630 Aartselaar  
Tel.: +32-3-870 7300  
Fax: +32-3-870 7301

**Belarus**

Представительство ГРУНДФОС в  
Минске  
220125, Минск  
ул. Шафарнянская, 11, оф. 56, БЦ  
«Порт»  
Тел.: +375 17 397 397 3  
+375 17 397 397 4  
Факс: +375 17 397 397 1  
E-mail: minsk@grundfos.com

**Bosnia and Herzegovina**

GRUNDFOS Sarajevo  
Zmaja od Bosne 7-7A  
BiH-71000 Sarajevo  
Tel.: +387 33 592 480  
Fax: +387 33 590 465  
www.ba.grundfos.com  
E-mail: grundfos@bih.net.ba

**Brazil**

BOMBAS GRUNDFOS DO BRASIL  
Av. Humberto de Alencar Castelo  
Branco, 630  
CEP 09850 - 300  
São Bernardo do Campo - SP  
Tel.: +55-11 4393 5533  
Fax: +55-11 4343 5015

**Bulgaria**

Grundfos Bulgaria EOOD  
Slatina District  
Iztocna Tangenta street no. 100  
BG - 1592 Sofia  
Tel.: +359 2 49 22 200  
Fax: +359 2 49 22 201  
E-mail: bulgaria@grundfos.bg

**Canada**

GRUNDFOS Canada inc.  
2941 Brighton Road  
Oakville, Ontario  
L6H 6C9  
Tel.: +1-905 829 9533  
Fax: +1-905 829 9512

**China**

GRUNDFOS Pumps (Shanghai) Co. Ltd.  
10F The Hub, No. 33 Suhong Road  
Minhang District  
Shanghai 201106 PRC  
Tel.: +86 21 612 252 22  
Fax: +86 21 612 253 33

**Columbia**

GRUNDFOS Colombia S.A.S.  
Km 1.5 via Siberia-Cota Conj. Potrero  
Chico,  
Parque Empresarial Arcos de Cota Bod.  
1A.  
Cota, Cundinamarca  
Tel.: +57(1)-2913444  
Fax: +57(1)-8764586

**Croatia**

GRUNDFOS CROATIA d.o.o.  
Buzinski prilaz 38, Buzin  
HR-10010 Zagreb  
Tel.: +385 1 6595 400  
Fax: +385 1 6595 499  
www.hr.grundfos.com

**Czech Republic**

GRUNDFOS Sales Czechia and Slovakia  
s.r.o.  
Čajkovského 21  
779 00 Olomouc  
Tel.: +420-585-716 111

**Denmark**

GRUNDFOS DK A/S  
Martin Bachs Vej 3  
DK-8850 Bjerringbro  
Tel.: +45-87 50 50 50  
Fax: +45-87 50 51 51  
E-mail: info\_GDK@grundfos.com  
www.grundfos.com/DK

**Estonia**

GRUNDFOS Pumps Eesti OÜ  
Peterburi tee 92G  
11415 Tallinn  
Tel.: + 372 606 1690  
Fax: + 372 606 1691

**Finland**

OY GRUNDFOS Pumput AB  
Trukkikuja 1  
FI-01360 Vantaa  
Tel.: +358-(0) 207 889 500

**France**

Pompes GRUNDFOS Distribution S.A.  
Parc d'Activités de Chesnes  
57, rue de Malacombe  
F-38290 St. Quentin Fallavier (Lyon)  
Tel.: +33-4 74 82 15 15  
Fax: +33-4 74 94 10 51

**Germany**

GRUNDFOS GMBH  
Schlüterstr. 33  
40699 Erkrath  
Tel.: +49-(0) 211 929 69-0  
Fax: +49-(0) 211 929 69-3799  
E-mail: infoservice@grundfos.de  
Service in Deutschland:  
kundendienst@grundfos.de

**Greece**

GRUNDFOS Hellas A.E.B.E.  
20th km. Athinon-Markopoulou Av.  
P.O. Box 71  
GR-19002 Peania  
Tel.: +0030-210-66 83 400  
Fax: +0030-210-66 46 273

**Hong Kong**

GRUNDFOS Pumps (Hong Kong) Ltd.  
Unit 1, Ground floor, Siu Wai industrial  
Centre  
29-33 Wing Hong Street & 68 King Lam  
Street, Cheung Sha Wan  
Kowloon  
Tel.: +852-27861706 / 27861741  
Fax: +852-27858664

**Hungary**

GRUNDFOS Hungária Kft.  
Tópark u. 8  
H-2045 Törökbalint  
Tel.: +36-23 511 111  
Fax: +36-23 511 111

**India**

GRUNDFOS Pumps india Private Limited  
118 Old Mahabalipuram Road  
Thoraiakkam  
Chennai 600 097  
Tel.: +91-44 2496 6800

**Indonesia**

PT GRUNDFOS Pompa  
Graha intirub Lt. 2 & 3  
Jln. Cililitan Besar No.454, Makasar,  
Jakarta Timur  
ID-Jakarta 13650  
Tel.: +62 21-469-51900  
Fax: +62 21-460 6910 / 460 6901

**Ireland**

GRUNDFOS (Ireland) Ltd.  
Unit A, Merrywell Business Park  
Ballymount Road Lower  
Dublin 12  
Tel.: +353-1-4089 800  
Fax: +353-1-4089 830

**Italy**

GRUNDFOS Pompe Italia S.r.l.  
Via Gran Sasso 4  
I-20060 Truccazzano (Milano)  
Tel.: +39-02-95838112  
Fax: +39-02-95309290 / 95838461

**Japan**

GRUNDFOS Pumps K.K.  
1-2-3, Shin-Miyakoda, Kita-ku  
Hamamatsu  
431-2103 Japan  
Tel.: +81 53 428 4760  
Fax: +81 53 428 5005

**Korea**

GRUNDFOS Pumps Korea Ltd.  
6th Floor, Aju Building 679-5  
Yeoksam-dong, Kangnam-ku, 135-916  
Seoul, Korea  
Tel.: +82-2-5317 600  
Fax: +82-2-5633 725

**Latvia**

SIA GRUNDFOS Pumps Latvia  
 Deglava biznesa centrs  
 Augusta Deglava ielā 60  
 LV-1035, Rīga,  
 Tel.: + 371 714 9640, 7 149 641  
 Fax: + 371 914 9646

**Lithuania**

GRUNDFOS Pumps UAB  
 Smolensko g. 6  
 LT-03201 Vilnius  
 Tel.: + 370 52 395 430  
 Fax: + 370 52 395 431

**Malaysia**

GRUNDFOS Pumps Sdn. Bhd.  
 7 Jalan Peguam U1/25  
 Glenmarie Industrial Park  
 40150 Shah Alam, Selangor  
 Tel.: +60-3-5569 2922  
 Fax: +60-3-5569 2866

**Mexico**

Bombas GRUNDFOS de México  
 S.A. de C.V.  
 Boulevard TLC No. 15  
 Parque industrial Stiva Aeropuerto  
 Apodaca, N.L. 66600  
 Tel.: +52-81-8144 4000  
 Fax: +52-81-8144 4010

**Netherlands**

GRUNDFOS Netherlands  
 Veluwezoom 35  
 1326 AE Almere  
 Postbus 22015  
 1302 CA ALMERE  
 Tel.: +31-88-478 6336  
 Fax: +31-88-478 6332  
 E-mail: info\_gnl@grundfos.com

**New Zealand**

GRUNDFOS Pumps NZ Ltd.  
 17 Beatrice Tinsley Crescent  
 North Harbour Industrial Estate  
 Albany, Auckland  
 Tel.: +64-9-415 3240  
 Fax: +64-9-415 3250

**Norway**

GRUNDFOS Pumper A/S  
 Strømsveien 344  
 Postboks 235, Leirdal  
 N-1011 Oslo  
 Tel.: +47-22 90 47 00  
 Fax: +47-22 32 21 50

**Poland**

GRUNDFOS Pompy Sp. z o.o.  
 ul. Klonowa 23  
 Baranowo k. Poznania  
 PL-62-081 Przemierowo  
 Tel.: (+48-61) 650 13 00  
 Fax: (+48-61) 650 13 50

**Portugal**

Bombas GRUNDFOS Portugal, S.A.  
 Rua Calvet de Magalhães, 241  
 Apartado 1079  
 P-2770-153 Paço de Arcos  
 Tel.: +351-21-440 76 00  
 Fax: +351-21-440 76 90

**Romania**

GRUNDFOS Pompe România SRL  
 S-PARK BUSINESS CENTER, Clădirea  
 A2, etaj 2  
 Str. Tipografilor, Nr. 11-15, Sector 1, Cod  
 013714  
 Bucuresti, Romania  
 Tel.: 004 021 2004 100  
 E-mail: romania@grundfos.ro

**Russia**

ООО Грундфос Россия  
 ул. Школьная, 39-41  
 Москва, RU-109544, Russia  
 Тел. (+7) 495 564-88-00 (495) 737-30-00  
 Факс (+7) 495 564 8811  
 E-mail grundfos.moscow@grundfos.com

**Serbia**

Grundfos Srbija d.o.o.  
 Omladinskih brigada 90b  
 11070 Novi Beograd  
 Tel.: +381 11 2258 740  
 Fax: +381 11 2281 769  
 www.rs.grundfos.com

**Singapore**

GRUNDFOS (Singapore) Pte. Ltd.  
 25 Jalan Tukang  
 Singapore 619264  
 Tel.: +65-6681 9688  
 Fax: +65-6681 9689

**Slovakia**

GRUNDFOS s.r.o.  
 Prievozská 4D 821 09 BRATISLAVA  
 Tel.: +421 2 5020 1426  
 sk.grundfos.com

**Slovenia**

GRUNDFOS LJUBLJANA, d.o.o.  
 Leskoškova 9e, 1122 Ljubljana  
 Tel.: +386 (0) 1 568 06 10  
 Fax: +386 (0)1 568 06 19  
 E-mail: tehnika-si@grundfos.com

**South Africa**

GRUNDFOS (PTY) LTD  
 16 Lascelles Drive, Meadowbrook Estate  
 1609 Germiston, Johannesburg  
 Tel.: (+27) 10 248 6000  
 Fax: (+27) 10 248 6002  
 E-mail: lgradidge@grundfos.com

**Spain**

Bombas GRUNDFOS España S.A.  
 Camino de la Fuentesilla, s/n  
 E-28110 Algete (Madrid)  
 Tel.: +34-91-848 8800  
 Fax: +34-91-628 0465

**Sweden**

GRUNDFOS AB  
 Box 333 (Lunnagårdsgatan 6)  
 431 24 Mölndal  
 Tel.: +46 31 332 23 000  
 Fax: +46 31 331 94 60

**Switzerland**

GRUNDFOS Pumpen AG  
 Bruggacherstrasse 10  
 CH-8117 Fällanden/ZH  
 Tel.: +41-44-806 8111  
 Fax: +41-44-806 8115

**Taiwan**

GRUNDFOS Pumps (Taiwan) Ltd.  
 7 Floor, 219 Min-Chuan Road  
 Taichung, Taiwan, R.O.C.  
 Tel.: +886-4-2305 0868  
 Fax: +886-4-2305 0878

**Thailand**

GRUNDFOS (Thailand) Ltd.  
 92 Chalome Phrakiat Rama 9 Road  
 Dokmai, Pravej, Bangkok 10250  
 Tel.: +66-2-725 8999  
 Fax: +66-2-725 8998

**Turkey**

GRUNDFOS POMPA San. ve Tic. Ltd.  
 Sti.  
 Gebze Organize Sanayi Bölgesi  
 Ihsan dede Caddesi  
 2. yol 200. Sokak No, 204  
 41490 Gebze/ Kocaeli  
 Tel.: +90 - 262-679 7979  
 Fax: +90 - 262-679 7905  
 E-mail: satis@grundfos.com

**Ukraine**

ТОВ "ГРУНДФОС УКРАЇНА"  
 Бізнес Центр Європа  
 Столицне шосе, 103  
 м. Київ, 03131, Україна  
 Tel.: (+38 044) 237 04 00  
 Fax: (+38 044) 237 04 01  
 E-mail: ukraine@grundfos.com

**United Arab Emirates**

GRUNDFOS Gulf Distribution  
 P.O. Box 16768  
 Jebel Ali Free Zone, Dubai  
 Tel.: +971 4 8815 166  
 Fax: +971 4 8815 136

**United Kingdom**

GRUNDFOS Pumps Ltd.  
 Grovebury Road  
 Leighton Buzzard/Beds. LU7 4TL  
 Tel.: +44-1525-850000  
 Fax: +44-1525-850011

**U.S.A.**

Global Headquarters for WU  
 856 Koomey Road  
 Brookshire, Texas 77423 USA  
 Phone: +1-630-236-5500

**Uzbekistan**

Grundfos Tashkent, Uzbekistan  
 The Representative Office of Grundfos  
 Kazakhstan in Uzbekistan  
 38a, Oybek street, Tashkent  
 Tel.: (+998) 71 150 3290 / 71 150 3291  
 Fax: (+998) 71 150 3292

<b>98552055</b> 06.2022
-------------------------

ECM: 1337196
--------------

[www.grundfos.com](http://www.grundfos.com)

**GRUNDFOS** 

Trademarks displayed in this material, including but not limited to Grundfos and the Grundfos logo, are registered trademarks owned by The Grundfos Group. © 2022 Grundfos Holding A/S, all rights reserved.