

Permanent Magnet motors

for submersible borehole pumps
50 Hz



1. Product introduction	3
Range	4
2. Construction	6
3. Technical data	7
Motor data	7
Motor efficiency overview	8
Motor cable	9
Motor dimensions and weight	10
4. Accessories	11
PT100 temperature sensor	11
Cable termination kit, type KM	11
Sizing of drop cables	13
Submersible drop cables	13
Flow sleeves	14
Variable speed drive	14
Sine-wave output filters	16
5. Grundfos Product Center	18

1. Product introduction

System efficiency for pump systems with many operating hours is the main driver of operating costs in a pump system with larger pumps. System efficiency is a combination of the individual efficiencies of the pump, the motor, the frequency converter, the electric cables, the power quality, the water pipe resistance and the installation design. All these system components must be optimised in a pump system and the system must be properly maintained to keep the cost of ownership as low as possible. All these components must be taken into consideration when designing a pump system.

Grundfos offers a wide range of submersible borehole pumps (SP) with robust and efficient motors that offer a high efficiency with low cost of ownership. The optimal pump, motor and cables can easily be selected with the Grundfos product selection tool "Product Center" at <http://product-selection.grundfos.com/>.

To improve the overall efficiency even further, Grundfos also offers a range of high efficiency motors called submersible permanent magnet (PM) motors. PM motors are developed for submersible borehole pumps and form together with the high efficiency SP pumps a perfect energy-efficient solution for water

intake, irrigation, pressure boosting, fountains and many other borehole or well applications with clean water.

PM motors are characterised by having a rotor that is permanently magnetised and thus having virtually no rotor losses. This leads to a high efficiency compared to "normal" asynchronous motors.

The PM motor is a 4-pole motor and must via a frequency converter be supplied with up to 100 Hz, meaning it is running at 3000 rpm while "normal" asynchronous motors are running at approximately 2800 rpm. This means that for a given duty point, it is possible to select a pump with less number of stages to achieve the required duty.

A PM motor must be operated via a frequency converter and the converter must be of the type "IPM compatible".

An output filter must be installed between the frequency converter and the motor to smoothen the power supply and limit voltage peaks to the motor since the frequency converter otherwise causes stress on the motor windings and risk of reduced lifetime.

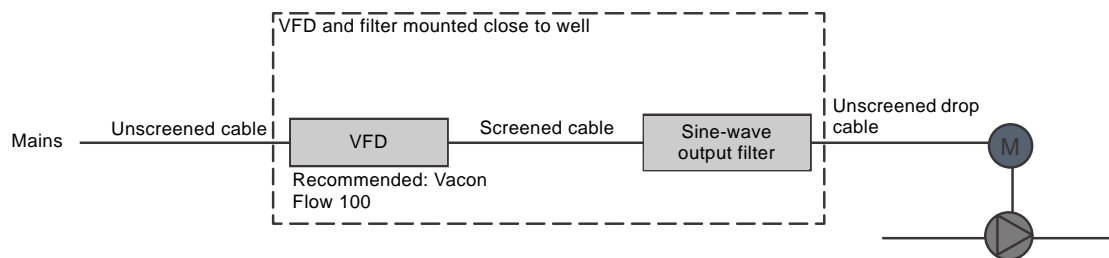

TM07 2813 4418

Fig. 1 Bore hole installation with frequency converter and output filter

Grundfos offers frequency converters and filters to match the submersible PM motors.

By using a PM motor compared to a standard asynchronous motor, a system efficiency increase of up to 10 % can be gained as well as an increased lifetime of the motor due to less heat increase.

Grundfos can assist in selecting the right pump, motor, frequency converter, cable and filter for your requirements to ensure a trouble-free operation. Grundfos offers an entire system solution from pump to a complete control cabinet with all the required components and features, including start-up and commissioning.

Range

Grundfos offers PM motors for submersible pumps from 4 to 150 kW in six sizes with 6" and 8" motor diameter. The motors are used in intervals as shown in the table below. The efficiency curve overview in [Motor efficiency overview](#) helps select the most efficient solution in relation to the power need.

The frequency converter is selected to cover the actual need of the selected pump.

6" PM motors	8" PM motors
4.0 to 7.5 kW output (P2)	45 to 75 kW output (P2)
9.3 to 18.5 kW output (P2)	75 to 100 kW output (P2)
22 to 37 kW output (P2)	100 to 150 kW output (P2)

The motors are available in the following material variants:

6" motors:

- Stainless steel DIN 1.4301/AISI 304
- Stainless steel DIN 1.4401/AISI 316 (available on request)
- Stainless steel DIN 1.4539/AISI 904L (available on request).

8" motors

- Cast iron 6625/EN-JL 1040
- Stainless steel DIN 1.4401/AISI 316 (available on request)
- Stainless steel DIN 1.4539/AISI 904L (available on request).

The motors are with PE2/PA windings for 3 x 400 V, 100 Hz delivered by a frequency converter. The motors are for vertical installation only. The pump and motor are drinking water approved.

The following motor numbers are for motors in stainless steel DIN 1.4301/AISI304 in 6" and for cast iron 6625/EN-JL1040 in 8".

The motor may be equipped with a PT100 temperature sensor on request.

For 50 Hz, 3 × 400 V + 10 %/- 10 % mains supply								
Permanent Magnet motor				Variable speed drive		Sine-wave output filter		
Motor P2 [kW]	Motor I _N [A]	Motor number	Motor description ¹	Drive number ²	Current rating and IP class	Filter number ³	Current rating at 100 Hz	IP class
4.0 5.5 7.5	8 10 13	99209294	FR PM 6" 3 x 400/100 Hz, 4.0 - 7.5 kW	99209299	16 A, IP21	96754976	13 A	IP20
9.3 11 13 15	18 20 23 26	99209416	FR PM 6" 3 x 400/100 Hz, 9.3 - 18.5 kW	99209497	23 A, IP21	96754977 96754978	18 A 28.5 A	IP20
18.5	32	99209416	FR PM 6" 3 x 400/100 Hz, 9.3 - 18.5 kW	99209500	38 A, IP21	96754978	28.5 A	IP20
22 26 30	39 46 54	99209417	FR PM 6" 3 x 400/100 Hz, 22-37 kW	99209501	61 A, IP21	96755021 97774436	46.5 A 86 A	IP20 IP23
37	72	99209417	FR PM 6" 3 x 400/100 Hz, 22-37 kW	99209502	87 A, IP21	97774436	86 A	IP23
45	74	99209465	FR PM 8" 3 x 400/100 Hz, 45-75 kW	99209502	87 A, IP21	97774436	86 A	IP23
55 67 75	91 112 128	99209465	FR PM 8" 3 x 400/100 Hz, 45-75 kW	99209513	140 A, IP21	97775142	135 A	IP23
75 83 93 100	129 143 162 178	99209470	FR PM 8" 3 x 400/100 Hz, 75-100 kW	99209513	140 A, IP21	97775142	135 A	IP23
100 110	176 193	99209496	FR PM 8" 3 x 400/100 Hz, 100-150 kW	99209514	205 A, IP21	97775146	195 A	IP23
130 150	229 270	99209496	FR PM 8" 3 x 400/100 Hz, 100-150 kW	99209515	310 A, IP00	97775148	308 A	IP23
4.0 5.5 7.5	8 10 13	99209294	FR PM 6" 3 x 400/100 Hz, 4.0 - 7.5 kW	99209513	16 A, IP66	96754976	13 A	IP20
9.3 11	18 20	99209416	FR PM 6" 3 x 400/100 Hz, 9.3 - 18.5 kW	99209517	23 A, IP66	96754977 96754978	18 A 28.5 A	IP20 IP20
13 15 18.5	23 26 32	99209416	FR PM 6" 3 x 400/100 Hz, 9.3 - 18.5 kW	99209518	38 A, IP66	96754978 96755019	28.5 A 36 A	IP20 IP20
22 26 30	39 46 54	99209417	FR PM 6" 3 x 400/100 Hz, 22-37 kW	99209519	61 A, IP66	96755021 97774436	46.5 A 86 A	IP20 IP23
37	72	99209417	FR PM 6" 3 x 400/100 Hz, 22-37 kW	-	-	97774436	86 A	IP23
45	74	99209465	FR PM 8" 3 x 400/100 Hz, 45-75 kW	99209520	140 A, IP54	97774436	86 A	IP23
55 67 75	91 112 128	99209465	FR PM 8" 3 x 400/100 Hz, 45-75 kW	99209520	140 A, IP54	97775142	135 A	IP23
75	129	99209470	FR PM 8" 3 x 400/100 Hz, 75-100 kW	99209520	140 A, IP54	97775142	135 A	IP23
83 93 100	143 162 178	99209470	FR PM 8" 3 x 400/100 Hz, 75-100 kW	99209521	205 A, IP54	97775146	195 A	IP23
100 110	176 193	99209496	FR PM 8" 3 x 400/100 Hz, 100-150 kW	99209521	205 A, IP54	97775146	195 A	IP23
130 150	229 270	99209496	FR PM 8" 3 x 400/100 Hz, 100-150 kW	99209522	310 A, IP54	97775148	308 A	IP23

¹ The offered motor is manufactured and branded Franklin Electric and supported by Grundfos warranty.

² The offered variable speed drive is manufactured and branded by Danfoss/Vacon and supported by Grundfos warranty. Note that Grundfos CUE frequency converters cannot be used for PM motors.

³ The offered Sine-wave output filter is branded by Danfoss and supported by Grundfos warranty. The filter is selected for 100 Hz operation.

2. Construction

The motors are designed and manufactured by Franklin Electric and with Franklin Electric branding.

The motor is a 4-pole, synchronous squirrel-cage submersible motor with built-in MICHELL type thrust bearing. The thrust bearing consists of:

- A carbon graphite rotating part with precision-ground and polished sliding surface for optimum surface finish.
- A stationary part which has moveable, specially ground tempered stainless-steel shoes for all sizes. It is moveable in such way that all tolerances are absorbed and thus the bearing achieves optimum thrust capacity and minimum friction.

The motor has standardised D-end according to NEMA standard MG 1-18.413.

The stator is wet-wound with PE2/PA rewindable windings, and the rotor is permanently magnetised.

Material specification		
Components	6" motors	8" motors
Shaft extension	1.4021	1.4460
Sand slinger	NBR	NBR
Shaft seal	SIC/SIC	SIC/SIC
Motor sleeve	1.4301	1.4301
Motor top	1.4308	Cast iron, powder coated
Motor bottom	1.4301	Cast iron, powder coated
Diaphragm	EPDM	EPDM

The rubber diaphragm fitted between the stator and the motor-end shield is dimensioned to equalise volume variations caused by the temperature rises during intermittent operation.

PM motors must be installed vertically.

The motor is filled with a glycerol-containing motor-liquid, which is frost-protected down to -15 °C. The motor liquid has an anti-corrosive and lubricating function. If the motor-liquid is not allowed for special applications, PM motors can be filled with fresh water. In that case, it must be ensured that the motor is not exposed to frost.

3. Technical data

Mains supply: 3 x 400 V + 10 %/- 10 %, 50 Hz

Pole number: 4

Supply to motor: 60 to 100 Hz

Motor enclosure class: IP68

Motor winding: PE2/PA

Shaft seal: SIC/SIC/NBR

Storage temperature: -15 to +60 °C

Media temperature:

- 6" motor: 30 °C with 0.2 m/sec cooling flow past the motor.
- 8" motors: 30 °C with 0.5 m/sec cooling flow past the motor.

Maximum number of starts per hour:

- 6" motors: 20 with minimum 3 minutes rest period between each start
- 8" motors: 10 with minimum 3 minutes rest period between each start.

Cables between the frequency converter and the filter must be screened EMC cables whereas the cable from filter to motor can be unscreened cable.

Motor data

Motor P2 [kW]	Motor number	Motor description	Motor in [A]	Power factor [cos phi]	Efficiency [%]	Nominal torque [Nm]	Winding resistance phase-phase [ohm]
4.0	99209294	FR PM 6" 3 x 400/100 Hz, 4.0 - 7.5 kW	8	0.95	88	12.9	1.914
5.5			10		89	17.5	
7.5			13		89.5	23.8	
9.3	99209416	FR PM 6" 3 x 400/100 Hz, 9.3 - 18.5 kW	18	0.95	91.5	29.6	0.635
11			20		92	35	
13			23		92.5	41.5	
15			26		92.5	46.1	
18.5			32		92	59	
22	99209417	FR PM 6" 3 x 400/100 Hz, 22-37 kW	39	0.95	93	70	0.359
26			46		92.5	82.6	
30			54		91.5	95.5	
37			72		90	117.8	
45	99209465	FR PM 8" 3 x 400/100 Hz, 45-75 kW	74	0.96	93.3	143	0.146
55			91		93.3	175	
67			112		93	213	
75			128		92.5	239	
75	99209470	FR PM 8" 3 x 400/100 Hz, 75-100 kW	129	0.95	93.5	239	0.103
83			143		93.5	264	
93			162		93	296	
100			178		92.7	319	
100	99209496	FR PM 8" 3 x 400/100 Hz, 100-150 kW	176	0.94	94.2	319	0.057
110			193		94.2	350	
130			229		94	413	
150			270		93.4	477	

Motor efficiency overview

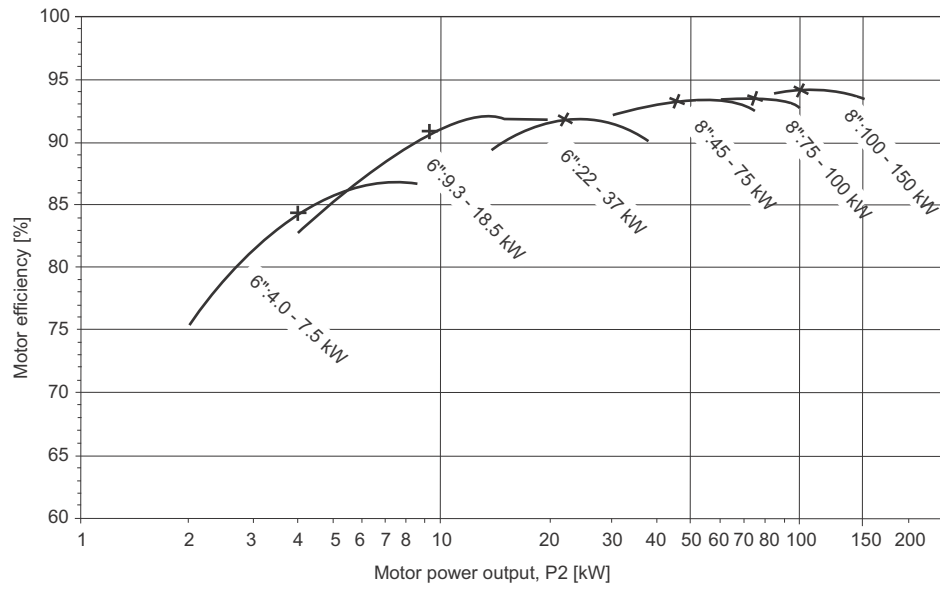
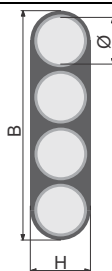
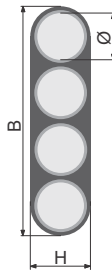
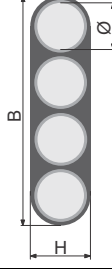
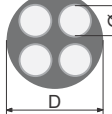
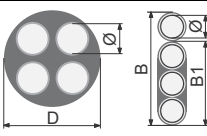

Fig. 2 Overview of motor efficiency

TM07 2814 4418

Motor cable

The motor cable is delivered together with the motor.

Motor size	Cable type and outer dimensions (H× B× D)	Cable length (m)	Number of leads and lead diameter (Ø, mm ²)	Cable layout
4-18 kW	Flat, 8.2 × 23 mm	4	4G4	 TM07 2808 4218
22-37 kW	Flat, 9.0 × 25 mm	4	4G6	 TM07 2808 4218
45-75 kW	Flat, 12.8 × 38 mm	6	4G16	 TM07 2808 4218
75-100 kW	Round, OD 32 mm	6	4G25	 TM07 2809 4218
100-150 kW	Flat + round, OD 32 mm + 16 × 37.5 mm	6	4G25 + 3G25	 TM07 2810 4218

See [Cable termination kit, type KM](#) and [Submersible drop cables](#).

Motor dimensions and weight

Motor size	Motor length L [mm]	Shaft length L _s [mm]	Motor diameter D [mm]	Weight		Packaging dimension		
				Without packaging	With packaging	B [mm]	H [mm]	L [mm]
4 - 7.5 kW	655	72.9	143	41	46	155	270	905
9.3 - 18.5 kW	809	72.9	143	56	61	155	270	1135
22-37 kW	971	72.9	143	72	77	155	270	1135
45-75 kW	1175	101.5	193.5	150	179	310	472	1596
75-100 kW	1286	101.5	193.5	169	198	310	472	1596
100-150 kW	1560	101.5	193.5	215	252	310	472	1596

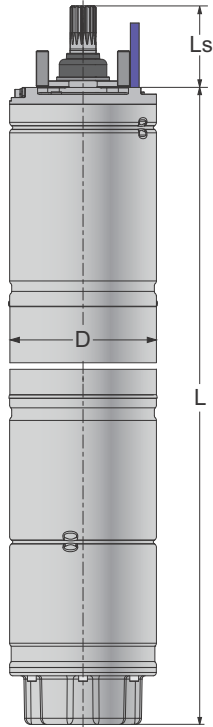

TM07 2999 4418

Fig. 3 Motor design

4. Accessories

Several installation accessories are available for the Grundfos SP pumps. This booklet only describes those relevant to the submersible PM motors. For SP pump accessories, see the SP documentation.

PT100 temperature sensor

For continuous measuring of the motor-liquid temperature, a PT100 sensor can be mounted in the top end of the motor.

The resistance of the PT100 sensor is proportional to the temperature.

The PT100 sensor can be connected to the frequency converter or available control cabinets. Connecting the PT100 sensor to the proposed Vacon converter requires a plug-in card in the converter.

Both PT100 sensors with different cable lengths and the mentioned plug-in card for the Vacon drive are available on request. Contact Grundfos for more information.

Cable termination kit, type KM

For instructions on how to make the cable termination between motor cable and drop cable, see the KM quick guide available at <http://net.grundfos.com/qr/i/V7065924> (Grundfos Product Center).

Grundfos recommendation:

First termination of motor cable and drop cable must be placed maximum 1/2 meter above the pump end.

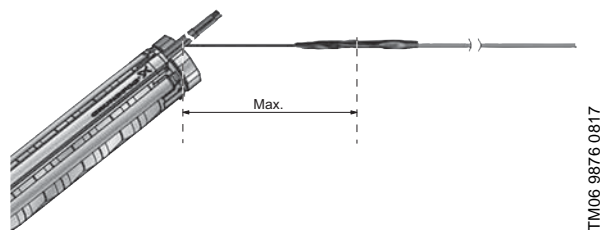









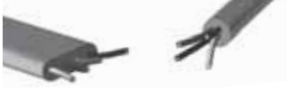



TM06 9876 0817



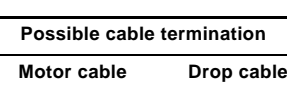
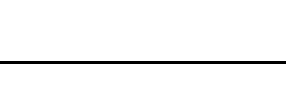

Fig. 4

Do not attempt to join two cables that have a larger cross section span than stated in the following table.

Motor cable [mm ²]	Drop cable, maximum increase per step [mm ²]			
2.5	6.0	16.0	50.0	-
6.0	16.0	35.0	70.0	150.0
10.0	25.0	50.0	120.0	240.0
16.0	50.0	120.0	240.0	-
25.0	70.0	150.0	240.0	-
35.0	70.0	150.0	240.0	-
50.0	120.0	240.0	-	-
70.0	150.0	240.0	-	-

Possible cable termination		Content of kit	Motor cable [mm ²]	Drop cable [mm ²]	Number of leads	Product number
Motor cable	Drop cable					
			KM kits with pressed connections:			
			1.5 - 6	1.5 - 6	4	00116251
			6-16	6-16	4	00116252
			KM kits with pressed connections:			
			10-25	10-25	4	00116255
			KM kits with screw connectors:			
			6-35	6-35	4	96636867
			25-70	25-70	4	96636868

Possible cable termination		Content of kit	Motor cable [mm ²]	Drop cable [mm ²]	Number of leads	Product number
Motor cable	Drop cable					
			KM kits with pressed connections:			
			1.5 - 6	1.5 - 6	4	00116257
			6-16	6-16	4	00116258
			KM kits with pressed connections:			
			10-50	10-50	4	96637330
			16-70	16-70	4	96637332
			KM kits with pressed connections:			
			1.5 - 6	1.5 - 6	3	00116253
			10-25	10-25	3	00116254
			KM kits with pressed connections:			
			10-50	10-50	3	96637318
			16-70	16-70	3	96637331

Possible cable termination		Content of kit	Motor cable [mm ²]	Drop cable [mm ²]	Number of leads	Product number
Motor cable	Drop cable					
			KM kits with pressed connections:			
			10-70	10-70	1	96828296
			32-120	32-120	1	00116256
			KM kits with screw connectors:			
			70-240	70-240	1	96637279

Note: A KM termination kit for single leads only consist of material for one connection. When ordering, keep in mind how many kits are needed for a complete cable termination.

Sizing of drop cables

The drop cable connects the motor cable in the well to the installation above ground.

To make a proper sizing of the drop cable, visit Grundfos Product Center (<http://product-selection.grundfos.com/>). Go to "Tools" in the menu bar and select "Cable Calculator".

You only need to fill in the needed cable length, motor current, maximum allowed voltage drop (default 3 %) and ambient temperature (default 20 °C). The calculator will tell you the needed minimum cable diameter.

Submersible drop cables

Grundfos offers submersible drop cables with free cable-ends and cut to the specified length. Grundfos can also offer to connect the drop cable to the motor cable using KM Termination kits.

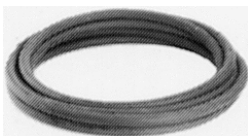
Product	Description	Number of leads and nominal cross-section [mm ²]	Outer cable diameter min. / max. [mm]	Weight [kg/m]	Product number
 <p style="writing-mode: vertical-rl; transform: rotate(180deg); font-size: small;">TM00 7882 2296</p>	<p>Suitable for these applications:</p> <ul style="list-style-type: none"> • continuous application in groundwater and potable water (approved for potable-water applications) • connection of electrical equipment, such as submersible motors • installation depths up to 600 metres and average loads. <p>Insulation and sheath of special EPR-based elastomer materials adapted to applications in water. Maximum permissible water temperature: 70 °C. Maximum permissible lead service temperature: 90 °C. Further cable sizes are available on request.</p>	1 x 25	12.5 / 16.5	0.410	00ID4072
		1 x 35	14.0 / 18.5	0.560	00ID4073
		1 x 50	16.5 / 21.0	0.740	00ID4074
		1 x 70	18.5 / 23.5	1.000	00ID4075
		1 x 95	21.0 / 26.5	1.300	00ID4076
		1 x 120	23.5 / 28.5	1.650	00ID4077
		1 x 150	26.0 / 31.5	2.000	00ID4078
		1 x 185	27.5 / 34.5	2.500	00ID4079
		4G1.5	10.5 / 13.5	0.190	00ID4063
		4G2.5	12.5 / 15.5	0.280	00ID4064
		4G4.0	14.5 / 18.0	0.390	00ID4065
		4G6.0	16.5 / 22.0	0.520	00ID4066
		4G10	22.5 / 24.5	0.950	00ID4067
		4G16	26.5 / 28.5	1.400	00ID4068
		4G25	32.0 / 34.0	1.950	00ID4069
		4G35	33.0 / 42.5	2.700	96432949
		4G50	38.0 / 48.5	3.600	96432950
		4G70	43.0 / 54.5	4.900	96432951

Flow sleeves

Grundfos recommends flow sleeves for all applications in which motor cooling is insufficient. The result is a general extension of motor life. Flow sleeves should be fitted in these cases:

- If the submersible pump is exposed to high thermal load such as current unbalance, dry running, overload, high ambient temperature and bad cooling conditions.
- If aggressive liquids are pumped, since corrosion is doubled for every 10 °C the temperature rises.
- If sedimentation or deposits occur around and/or on the motor.

The following minimum flow must be ensured past the motor to avoid overheating:

Media temperature:

- 6" motors 30 °C with 0.2 m/sec cooling flow past the motor
- 8" motors 30 °C with 0.5 m/sec cooling flow past the motor.

Grundfos offers a complete range of stainless-steel flow sleeves fitting the offered pump or motor combinations. Contact Grundfos for detailed information and inquiries.



TM01 0750 2197

Fig. 5 Flow sleeve

Example of calculated flow sleeve

The flow sleeve is fitted to the submersible motor so the liquid passes by the motor on its way towards the pump suction interconnector, thus ensuring optimum cooling of the motor.

The flow sleeve is designed so that the flow velocity past the motor is minimum 0.5 m/s and maximum 3 m/s to ensure optimum pump operating conditions.

Use this formula to calculate flow velocity:

$$V = \frac{Q \times 353}{D^2 - d^2} \text{ [m/s]}$$

Q	m ³ /h	Flow rate
D	mm	Sleeve diameter
d	mm	Motor diameter

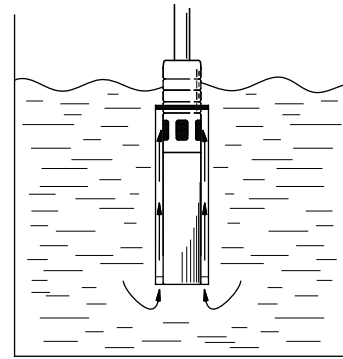

Fig. 6

TM01 0509 1297

Variable speed drive

A PM motor must be operated via a frequency converter and the converter must be of the type "IPM compatible".

Different manufacturers produce such converters and there are different brands to choose from.

Grundfos offers a range of frequency converters supporting PM motors. They include a startup wizard making correct setting and commissioning easy and safe. Order numbers for the range of converters can be found in [Range](#).

The installation must be equipped with an output filter to limit voltage peaks and to reduce dU/dt which causes stress on the isolation of the motor and risks reducing the lifetime of the product. The maximum voltage must be reduced to a level less than 850 V. dU/dt must be limited to a level less than 500 V/micro sec. For selection of filter, see [Range](#).



Fig. 7 Frequency converters

TM07 2026 4518 - TM07 2027 4518

Technical data for variable speed drive

Power supply	Input voltage U_N	380-500 V; + 10 %/- 10 %
	Input frequency	50 Hz
	Starts per hour	20 with minimum 3 minutes rest period
Motor connection	Output voltage	0 to U_N
	Output current	I_N at rated ambient temperature (40 °C) Overload: IP21: 1.1 x I_N IP66: 1.5 x I_N
	Output frequency	0 to f_N - Resolution 0.01 Hz
Performance	Efficiency	97.5 %
Control characteristics	Switching frequency	3.6 - 6.0 kHz. Default setting 4 kHz
	Operating temperature	-10 to +50 °C. Higher than 40 °C require derating.
Ambient conditions	Storage temperature	-40 to + 70 °C
	Altitude	Max. 3000 m. Higher than 1000 m require derating.
EMC	Immunity & Emissions	Complies with EN 61800-3, Category C3 - first and second environment
Communication	RS 485	Standard: Modbus
	Ethernet	Standard: Modbus
I/O Connections	Digital input (DI)	6 x
	Analog input (AI)	2 x
	Analogue output (AO)	1 x
	Relay output (RO)	2 x (change-over contact)

Variable speed drive dimensions and weight

Drive number	Current rating and IP class	Drawing	Dimensions, W x H x D [mm]	Weight [kg]
99209299	16 A, IP21	A	144 x 419 x 214	10
99209497	23 A, IP21	A	144 x 419 x 214	10
99209500	38 A, IP21	A	195 x 557 x 229	20
99209501	61 A, IP21	A	195 x 557 x 229	20
99209502	87 A, IP21	A	237 x 660 x 259	37.5
99209513	140 A, IP21	A	290 x 966 x 343	66
99209514	205 A, IP21	A	290 x 966 x 343	66
99209515	310 A, IP00	A	480 x 971 x 365	104
99209513	16 A, IP66	B	233 x 368 x 214	14.9
99209517	23 A, IP66	B	233 x 368 x 214	14.9
99209518	38 A, IP66	B	350 x 500 x 236	31.5
99209519	61 A, IP66	B	350 x 500 x 236	31.5
99209520	140 A, IP54	A	290 x 966 x 343	66
99209521	205 A, IP54	A	290 x 966 x 343	66
99209522	310 A, IP54	A	480 x 1150 x 365	108

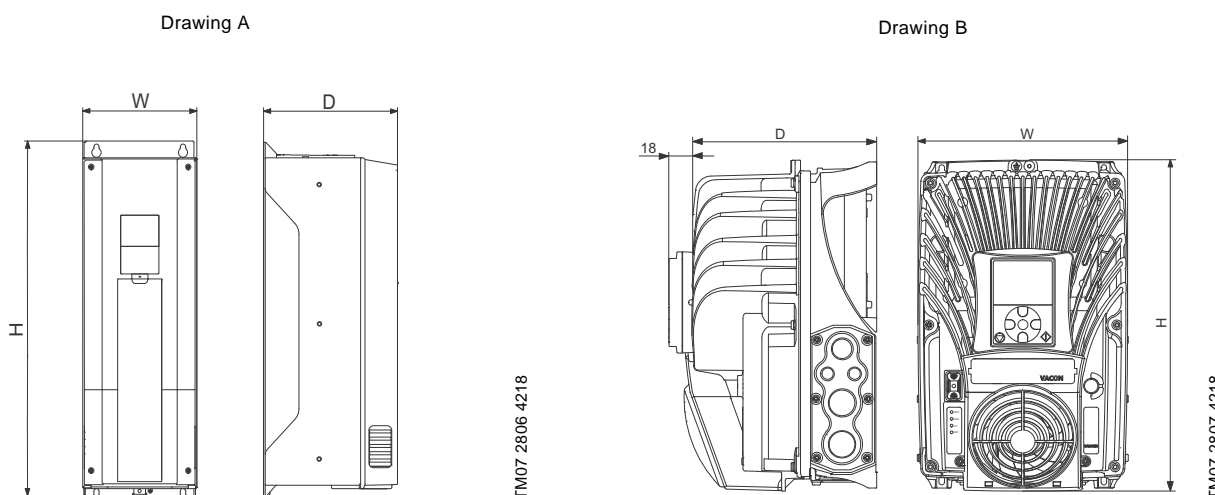

Fig. 8 Sectional drawing of the variable speed drive

Sine-wave output filters

When operating submersible motors on VFD, a filter must be used on the output side of the VFD to protect the motor and increase its lifetime. The filter will considerably improve:

- protection of motor insulation
- reduction of motor acoustic noise
- reduction of high frequency electromagnetic noise in motor cable.

Grundfos offers a range of Danfoss Sine-wave output filters for use with the described frequency converters and PM motors.



Fig. 9 Sine-wave output filters

The filter must be selected based on a derated maximum current as shown in the below table and in [Range](#). The reason is due to the output frequency of up to 100 Hz.

The losses in the filter can be seen from the table:

Output filter, technical data

Sine-wave output filter			
Filter number	Filter size at 100 Hz	IP class	Max. filter losses (Watt)
96754976	13 A	IP20	125
96754977	18 A	IP20	150
96754978	28.5 A	IP20	180
96755019	36 A	IP20	270
96755021	46.5 A	IP20	310
97774436	86 A	IP23	470
97775142	135 A	IP23	650
97775146	195 A	IP23	850
97775148	308 A	IP23	1150

Output filter, dimensions and weight

Sine-wave output filter			Dimensions (mm)									Weight [kg]
Filter number	Filter size at 100 Hz	IP class	Height, A	Width, B	Depth, C	a	b	c	d	e	f	
96754976	13 A	IP20	268	130	205	257	90	8	11	6.5	6.5	9.1
96754977	18 A	IP20	330	150	260	312	120	12	19	9	9	16.9
96754978	28.5 A	IP20	430	150	259	412	120	12	19	9	9	19.9
96755019	36 A	IP20	530	170	260	500	125	12	19	9	20	39
96755021	46.5 A	IP20	610	170	260	580	125	12	19	9	20	41
97774436	86 A	IP23	918	904	792	898	779	661	*	11	22	205
97775142	135 A	IP23	918	904	792	898	779	661	*	11	22	237
97775146	195 A	IP23	918	904	792	898	779	661	*	11	22	307
97775148	308 A	IP23	918	904	792	898	779	661	*	11	22	370

* Floor mounted version. Other versions are wall mounted versions.

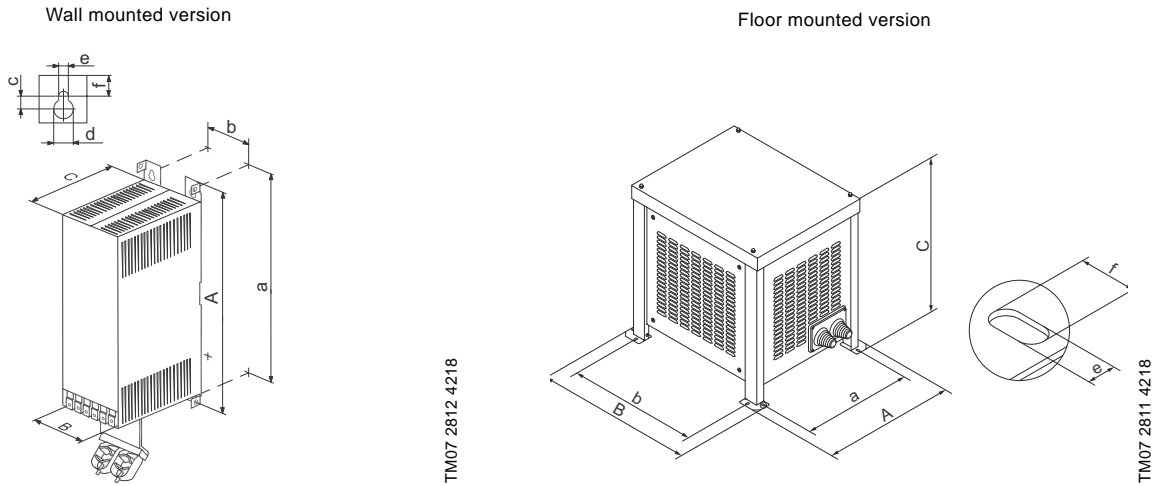

Fig. 10 Dimensions for Sine-wave output filters

5. Grundfos Product Center

Online search and sizing tool to help you make the right choice.

<http://product-selection.grundfos.com>



This drop-down menu enables you to set the search function to "Products" or "Literature".

"SIZING" enables you to size a pump based on entered data and selection choices.

"REPLACEMENT" enables you to find a replacement product. Search results will include information on the following:

- the lowest purchase price
- the lowest energy consumption
- the lowest total life cycle cost.

The screenshot shows the Grundfos Product Center website. At the top, there is a navigation bar with the Grundfos logo and 'PRODUCT CENTER'. Below this is a search bar with a dropdown menu set to 'Products'. The main content area features four large buttons: 'Sizing', 'Catalogue', 'Replacement', and 'Liquids'. Below these buttons is a 'Quick sizing' section with input fields for 'Flow (Q)' and 'Head (H)', and radio buttons for 'Size by application', 'Size by pump design', and 'Size by pump family'. A 'START SIZING' button is located at the bottom right of the quick sizing section.

"CATALOGUE" gives you access to the Grundfos product catalogue.

"LIQUIDS" enables you to find pumps designed for aggressive, flammable or other special liquids.

All the information you need in one place

Performance curves, technical specifications, pictures, dimensional drawings, motor curves, wiring diagrams, spare parts, service kits, 3D drawings, documents, system parts. The Product Center displays any recent and saved items - including complete projects - right on the main page.

Downloads

On the product pages, you can download installation and operating instructions, data booklets, service instructions, etc. in PDF format.

99525798 1118

ECM: 1245675

GRUNDFOS A/S
DK-8850 Bjerringbro . Denmark
Telephone: +45 87 50 14 00
www.grundfos.com

GRUNDFOS 